

WALL/DUCT

Extractores dinámicos murales con compuerta de apertura motorizada

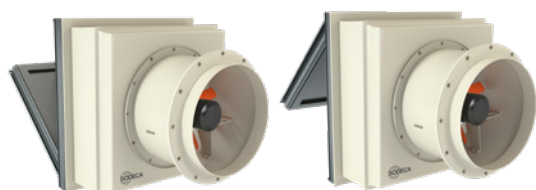

Extractores dinámicos murales de apertura motorizada, con posibilidad de ser conectados a conducto de extracción. Apto para instalación en naves industriales, edificios comerciales o cualquier otro tipo de edificación.

Ventilador:

- Brida de fijación a pared y pie soporte aro helicoidal para la correcta y fácil instalación.
- Envolvente tubular en chapa de acero con caja de bornes exterior.
- Hélice versión PL en poliamida 6 reforzada con fibra de vidrio y versión AL en fundición de aluminio. Los modelos 40-2T, 45-2T, 100-4T-15, 100-4T-20 y todos los 125 sólo en versión AL.
- Dirección aire motor-hélice.

Compuerta de aluminio extruido:

- Estructura de gran robustez para resistir severas condiciones climáticas.
- Diseñado para asegurar la estanqueidad a la entrada de agua.
- Perfil de aluminio con rotura de puente térmico.
- Plafón central y estructura dotados de aislante térmico de altas prestaciones.
- Resistividad térmica del conjunto menor que 0,89 W/m²·K.
- Indicadores de posición en ambas posiciones (abierto y cerrado).
- Versiones de montaje en apertura superior e inferior.
- Sistema de apertura manual.

- Valor del aislamiento acústico al ruido aéreo según UNE-EN ISO 10140-2: $R_w = 27 (0;-2) \text{ dB}$.

Motor:

- Motores con eficiencia IE3.
- Motores clase F con rodamientos a bolas y protección IP55.
- Trifásico 230/400 V 50 Hz (hasta 4 kW) y 400/690 V 50 Hz (potencias superiores a 4 kW).
- Temperatura de trabajo: -25 °C +60 °C.

Actuador:

- Fiabilidad mayor a 20.000 dobles ciclos.
- Tensión de alimentación 230 V AC 50/60 Hz.
- Temperatura de trabajo: -25 °C +60 °C.
- Protección en el borde principal al cerrar la compuerta.
- El tope en la posición de cierre está regulado por un control de final de carrera electrónico.

Acabado compuerta:

- Anticorrosivo en aluminio extruido.
- Color estándar RAL 7024M. Bajo demanda cualquier color de la carta RAL.

Bajo demanda:

- AA: sentido del aire hélice-motor, para entrada de aire hacia dentro del local.
- Actuador con tensión de alimentación 24 V DC.

Código de pedido

De tamaño 40 a tamaño 56

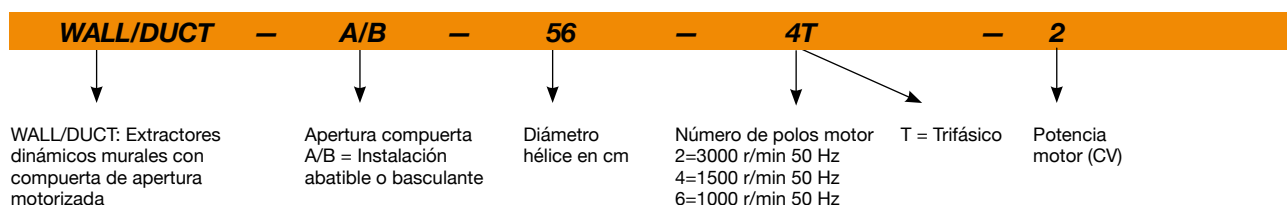

De tamaño 63 a tamaño 125

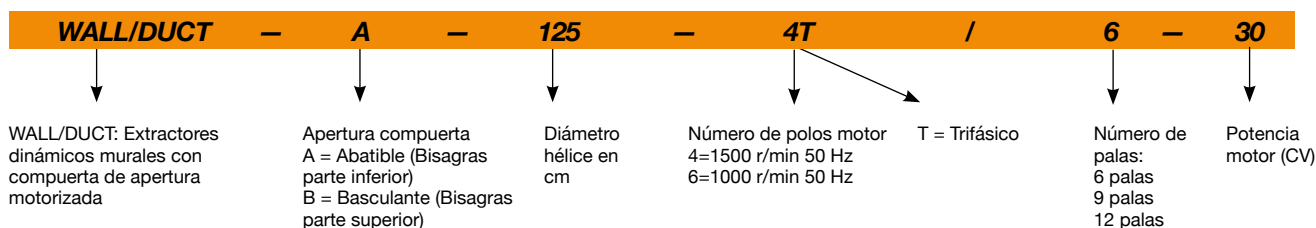



Erp. (Energy Related Products)

Información de la Directiva 2009/125/EC descargable desde la web de SODECA o programa de selección QuickFan

Características técnicas

Modelo	Velocidad (r/min)	Intensidad máxima admisible (A)			Potencia instalada (kW)	Caudal máximo (m³/h)	Nivel de presión sonora ¹ dB (A)		Peso aprox. (Kg)
		230V	400V	690V			Aspiración	Descarga	
WALL/DUCT-40-2T-1.5 IE3	2830	4,03	2,34		1,10	8800	64	65	55
WALL/DUCT-45-2T-2 IE3	2875	5,34	3,07		1,50	10630	67	68	64
WALL/DUCT-45-2T-3 IE3	2910	7,32	4,21		2,20	12740	69	70	68
WALL/DUCT-45-4T-0.5	1370	2,02	1,17		0,37	7100	49	50	53
WALL/DUCT-50-4T-0.75	1420	2,17	1,25		0,55	10380	53	54	63
WALL/DUCT-56-4T-1 IE3	1420	2,82	1,62		0,75	12940	56	57	71
WALL/DUCT-56-4T-1.5 IE3	1455	4,07	2,34		1,10	14000	57	58	77
WALL/DUCT-56-4T-2 IE3	1440	5,41	3,11		1,50	15290	58	59	83
WALL/DUCT-56-6T-0.75	900	2,99	1,73		0,55	10000	45	46	70
WALL/DUCT-63-4T-1 IE3	1420	2,82	1,62		0,75	14140	58	59	98
WALL/DUCT-63-4T-1.5 IE3	1455	4,07	2,34		1,10	17000	59	60	104
WALL/DUCT-63-4T-2 IE3	1440	5,41	3,11		1,50	18900	60	61	111
WALL/DUCT-63-4T-3 IE3	1435	7,93	4,56		2,20	22090	61	62	113
WALL/DUCT-63-4T-4 IE3	1440	10,70	6,15		3,00	25390	62	63	119
WALL/DUCT-63-6T-0.75	900	2,99	1,73		0,55	12750	50	51	97
WALL/DUCT-71-4T-2 IE3	1440	5,41	3,11		1,50	21090	64	65	117
WALL/DUCT-71-4T-3 IE3	1435	7,93	4,56		2,20	23950	66	67	119
WALL/DUCT-71-4T-4 IE3	1440	10,70	6,15		3,00	29400	67	68	125
WALL/DUCT-71-6T-1 IE3	940	3,36	1,93		0,75	17250	53	54	112
WALL/DUCT-71-6T-1.5 IE3	945	4,68	2,69		1,10	20950	54	55	117
WALL/DUCT-80-4T-3 IE3	1435	7,93	4,56		2,20	27940	67	68	132
WALL/DUCT-80-4T-4 IE3	1440	10,70	6,15		3,00	32700	68	69	138
WALL/DUCT-80-4T-5.5 IE3	1450	13,90	8,00		4,00	37200	69	70	140
WALL/DUCT-80-6T-1.5 IE3	945	4,68	2,69		1,10	24250	57	58	131
WALL/DUCT-80-6T-2 IE3	950	6,43	3,70		1,50	27960	58	59	134
WALL/DUCT-90-4T-5.5 IE3	1450	13,90	8,00		4,00	41810	75	76	176
WALL/DUCT-90-4T-7.5 IE3	1465		10,30	5,97	5,50	47000	77	78	211
WALL/DUCT-90-4T-10 IE3	1465		13,90	8,06	7,50	53000	78	79	215
WALL/DUCT-90-6T-2 IE3	950	6,43	3,70		1,50	30000	63	64	167
WALL/DUCT-90-6T-3 IE3	950	9,08	5,22		2,20	35000	64	65	175
WALL/DUCT-90-6T-4 IE3	970	12,00	6,91		3,00	40000	65	66	193
WALL/DUCT-100-4T-7.5 IE3	1465		10,30	5,97	5,50	52470	80	81	221
WALL/DUCT-100-4T-10 IE3	1465		13,90	8,06	7,50	58500	81	82	224
WALL/DUCT-100-4T-15 IE3	1470		20,90	12,10	11,00	68000	82	83	262
WALL/DUCT-100-4T-20 IE3	1465		27,90	16,20	15,00	71850	83	84	273
WALL/DUCT-100-6T-3 IE3	950	9,08	5,22		2,20	40390	70	71	184
WALL/DUCT-100-6T-4 IE3	970	12,00	6,91		3,00	46950	71	72	202
WALL/DUCT-100-6T-5.5 IE3	960	15,60	8,99		4,00	52000	72	73	208
WALL/DUCT-125-4T/6-20 IE3	1470		27,90	16,20	15,00	78610	77	77	462
WALL/DUCT-125-4T/6-25 IE3	1470		35,10	20,30	18,50	92550	76	76	530
WALL/DUCT-125-4T/6-30 IE3	1470		41,00	23,80	22,00	98830	75	75	544
WALL/DUCT-125-4T/6-40 IE3	1475		57,10	33,10	30,00	117460	75	75	625
WALL/DUCT-125-4T/6-50 IE3	1480		66,80	38,70	37,00	131065	75	75	673
WALL/DUCT-125-4T/9-25 IE3	1470		35,10	20,30	18,50	79670	77	77	539
WALL/DUCT-125-4T/9-30 IE3	1470		41,00	23,80	22,00	88280	76	76	553
WALL/DUCT-125-4T/9-40 IE3	1475		57,10	33,10	30,00	104040	75	75	634
WALL/DUCT-125-4T/9-50 IE3	1480		66,80	38,70	37,00	118400	75	75	682
WALL/DUCT-125-4T/12-30 IE3	1475		41,00	23,80	22,00	62895	78	78	569
WALL/DUCT-125-4T/12-40 IE3	1470		57,10	33,10	30,00	79180	77	77	650

Características técnicas

Modelo	Velocidad (r/min)	Intensidad máxima admisible (A)			Potencia instalada (kW)	Caudal máximo (m³/h)	Nivel de presión sonora ¹ dB (A)		Peso aprox. (Kg)
		230V	400V	690V			Aspiración	Descarga	
WALL/DUCT-125-4T/12-50 IE3	1480		66,80	38,70	37,00	95715	76	76	693
WALL/DUCT-125-6T/6-5.5 IE3	960	15,60	8,99		4,00	51500	67	67	395
WALL/DUCT-125-6T/6-7.5 IE3	960		11,20	6,49	5,50	60635	65	65	402
WALL/DUCT-125-6T/6-10 IE3	960		14,80	8,58	7,50	72650	64	64	427
WALL/DUCT-125-6T/6-15 IE3	955		21,90	12,70	11,00	85870	64	64	457
WALL/DUCT-125-6T/6-20 IE3	970		28,20	16,30	15,00	92855	66	66	530
WALL/DUCT-125-6T/9-10 IE3	960		14,80	8,58	7,50	63490	67	67	436
WALL/DUCT-125-6T/9-15 IE3	955		21,90	12,70	11,00	77570	65	65	466
WALL/DUCT-125-6T/9-20 IE3	970		28,20	16,30	15,00	92970	65	65	539
WALL/DUCT-125-6T/9-25 IE3	975		35,90	20,80	18,50	96500	67	67	569
WALL/DUCT-125-6T/12-25 IE3	975		35,90	20,80	18,50	91680	67	67	579
WALL/DUCT-125-6T/12-30 IE3	975		42,40	24,60	22,00	102040	68	68	621
WALL/DUCT-125-6T/12-40 IE3	980		55,40	32,10	30,00	115940	72	72	739

1. Los valores de los niveles sonoros, son presiones en dB(A) medidos a 10 metros, en campo libre.

Características acústicas

Los valores indicados se obtienen en condiciones de laboratorio según la norma ISO 3744.

Espectro de potencia sonora Lw(A) en dB(A) por banda de frecuencia en Hz

Valores tomados a la aspiración con caudal máximo

	63	125	250	500	1000	2000	4000	8000
40-2T-1.5	55	70	89	88	89	88	83	74
45-2T-2	51	68	80	88	93	93	89	82
45-2T-3	53	70	82	90	95	95	91	84
45-4T-0.5	33	50	62	70	75	75	71	64
50-4T-0.75	37	54	67	74	79	80	75	68
56-4T-1	48	68	76	81	83	80	73	62
56-4T-1.5	49	69	77	82	84	81	74	63
56-4T-2	50	70	78	83	85	82	75	64
56-6T-0.75	37	57	65	70	72	69	62	51
63-4T-1	50	70	78	83	85	82	75	64
63-4T-1.5	51	71	79	84	86	83	76	65
63-4T-2	52	72	80	85	87	84	77	66
63-4T-3	53	73	81	86	88	85	78	67
63-4T-4	54	74	82	87	89	86	79	68
63-6T-0.75	42	62	70	75	77	74	67	56
71-4T-2	56	76	84	89	91	88	81	70
71-4T-3	58	78	86	91	93	90	83	72
71-4T-4	59	79	87	92	94	91	84	73
71-6T-1	45	65	73	78	80	77	70	59
71-6T-1.5	46	66	74	79	81	78	71	60
80-4T-3	59	79	87	92	94	91	84	73
80-4T-4	60	80	88	93	95	92	85	74
80-4T-5.5	61	81	89	94	96	93	86	75
80-6T-1.5	49	69	77	82	84	81	74	63
80-6T-2	50	70	78	83	85	82	75	64
90-4T-5.5	67	88	95	100	103	99	92	81
90-4T-7.5	69	90	97	102	105	101	94	83
90-4T-10	70	91	98	103	106	102	95	84
90-6T-2	55	76	83	88	91	87	80	69
90-6T-3	56	77	84	89	92	88	81	70
90-6T-4	57	78	85	90	93	89	82	71
100-4T-7.5	72	92	100	105	107	104	97	86
100-4T-10	73	93	101	106	108	105	98	87
100-4T-15	74	94	102	107	109	106	99	88
100-4T-20	75	95	103	108	110	107	100	89
100-6T-3	62	82	90	95	97	94	87	76
100-6T-4	63	83	91	96	98	95	88	77
100-6T-5.5	64	84	92	97	99	96	89	78
125-4T/6-20	69	85	96	103	104	102	95	87
125-4T/6-25	68	84	95	102	103	101	94	86
125-4T/6-30	67	83	94	101	102	100	93	85
125-4T/6-40	67	83	94	101	102	100	93	85
125-4T/6-50	67	83	94	101	102	100	93	85

Valores tomados a la descarga con caudal máximo

	63	125	250	500	1000	2000	4000	8000
40-2T-1.5	56	71	90	89	90	89	84	75
45-2T-2	52	69	81	89	94	94	90	83
45-2T-3	54	71	83	91	96	96	92	85
45-4T-0.5	34	51	63	71	76	76	72	65
50-4T-0.75	38	55	68	75	80	81	76	69
56-4T-1	49	69	77	82	84	81	74	63
56-4T-1.5	50	70	78	83	85	82	75	64
56-4T-2	51	71	79	84	86	83	76	65
56-6T-0.75	38	58	66	71	73	70	63	52
63-4T-1	51	71	79	84	86	83	76	65
63-4T-1.5	52	72	80	85	87	84	77	66
63-4T-2	53	73	81	86	88	85	78	67
63-4T-3	54	74	82	87	89	86	79	68
63-4T-4	55	75	83	88	90	87	80	69
63-6T-0.75	43	63	71	76	78	75	68	57
71-4T-2	57	77	85	90	92	89	82	71
71-4T-3	59	79	87	92	94	91	84	73
71-4T-4	60	80	88	93	95	92	85	74
71-6T-1	46	66	74	79	81	78	71	60
71-6T-1.5	47	67	75	80	82	79	72	61
80-4T-3	60	80	88	93	95	92	85	74
80-4T-4	61	81	89	94	96	93	86	75
80-4T-5.5	62	82	90	95	97	94	87	76
80-6T-1.5	50	70	78	83	85	82	75	64
80-6T-2	51	71	79	84	86	83	76	65
90-4T-5.5	68	89	96	101	104	100	93	82
90-4T-7.5	70	91	98	103	106	102	95	84
90-4T-10	71	92	99	104	107	103	96	85
90-6T-2	56	77	84	89	92	88	81	70
90-6T-3	57	78	85	90	93	89	82	71
90-6T-4	58	79	86	91	94	90	83	72
100-4T-7.5	73	93	101	106	108	105	98	87
100-4T-10	74	94	102	107	109	106	99	88
100-4T-15	75	95	103	108	110	107	100	89
100-4T-20	76	96	104	109	111	108	101	90
100-6T-3	63	83	91	96	98	95	88	77
100-6T-4	64	84	92	97	99	96	89	78
100-6T-5.5	65	85	93	98	100	97	90	79
125-4T/6-20	69	85	96	103	104	102	95	87
125-4T/6-25	68	84	95	102	103	101	94	86
125-4T/6-30	67	83	94	101	102	100	93	85
125-4T/6-40	67	83	94	101	102	100	93	85
125-4T/6-50	67	83	94	101	102	100	93	85

Características acústicas

Los valores indicados se obtienen en condiciones de laboratorio según la norma ISO 3744.

Espectro de potencia sonora Lw(A) en dB(A) por banda de frecuencia en Hz

Valores tomados a la aspiración con caudal máximo

	63	125	250	500	1000	2000	4000	8000
125-4T/9-25	67	81	94	102	104	101	96	88
125-4T/9-30	66	80	93	101	103	100	95	87
125-4T/9-40	65	79	92	100	102	99	94	86
125-4T/9-50	65	79	92	100	102	99	94	86
125-4T/12-30	68	82	95	103	105	102	97	89
125-4T/12-40	67	81	94	102	104	101	96	88
125-4T/12-50	66	80	93	101	103	100	95	87
125-6T/6-5.5	64	79	89	92	93	90	85	77
125-6T/6-7.5	62	77	87	90	91	88	83	75
125-6T/6-10	61	76	86	89	90	87	82	74
125-6T/6-15	61	76	86	89	90	87	82	74
125-6T/6-20	63	78	88	91	92	89	84	76
125-6T/9-10	61	76	87	93	94	88	84	77
125-6T/9-15	59	74	85	91	92	86	82	75
125-6T/9-20	59	74	85	91	92	86	82	75
125-6T/9-25	61	76	87	93	94	88	84	77
125-6T/12-25	61	76	87	93	94	88	84	77
125-6T/12-30	62	77	88	94	95	89	85	78
125-6T/12-40	66	81	92	98	99	93	89	82

Valores tomados a la descarga con caudal máximo

	63	125	250	500	1000	2000	4000	8000
125-4T/9-25	67	81	94	102	104	101	96	88
125-4T/9-30	66	80	93	101	103	100	95	87
125-4T/9-40	65	79	92	100	102	99	94	86
125-4T/9-50	65	79	92	100	102	99	94	86
125-4T/12-30	68	82	95	103	105	102	97	89
125-4T/12-40	67	81	94	102	104	101	96	88
125-4T/12-50	66	80	93	101	103	100	95	87
125-6T/6-5.5	64	79	89	92	93	90	85	77
125-6T/6-7.5	62	77	87	90	91	88	83	75
125-6T/6-10	61	76	86	89	90	87	82	74
125-6T/6-15	61	76	86	89	90	87	82	74
125-6T/6-20	63	78	88	91	92	89	84	76
125-6T/9-10	61	76	87	93	94	88	84	77
125-6T/9-15	59	74	85	91	92	86	82	75
125-6T/9-20	59	74	85	91	92	86	82	75
125-6T/9-25	61	76	87	93	94	88	84	77
125-6T/12-25	61	76	87	93	94	88	84	77
125-6T/12-30	62	77	88	94	95	89	85	78
125-6T/12-40	66	81	92	98	99	93	89	82

Accesorios



INT



CABLE BOX



VSD3/A-RFT
- VSD1/A-RFM



AET

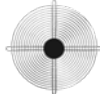

RT



BTUB



BAC



PS



ACE ACE/400



S



PV

Dimensiones mm

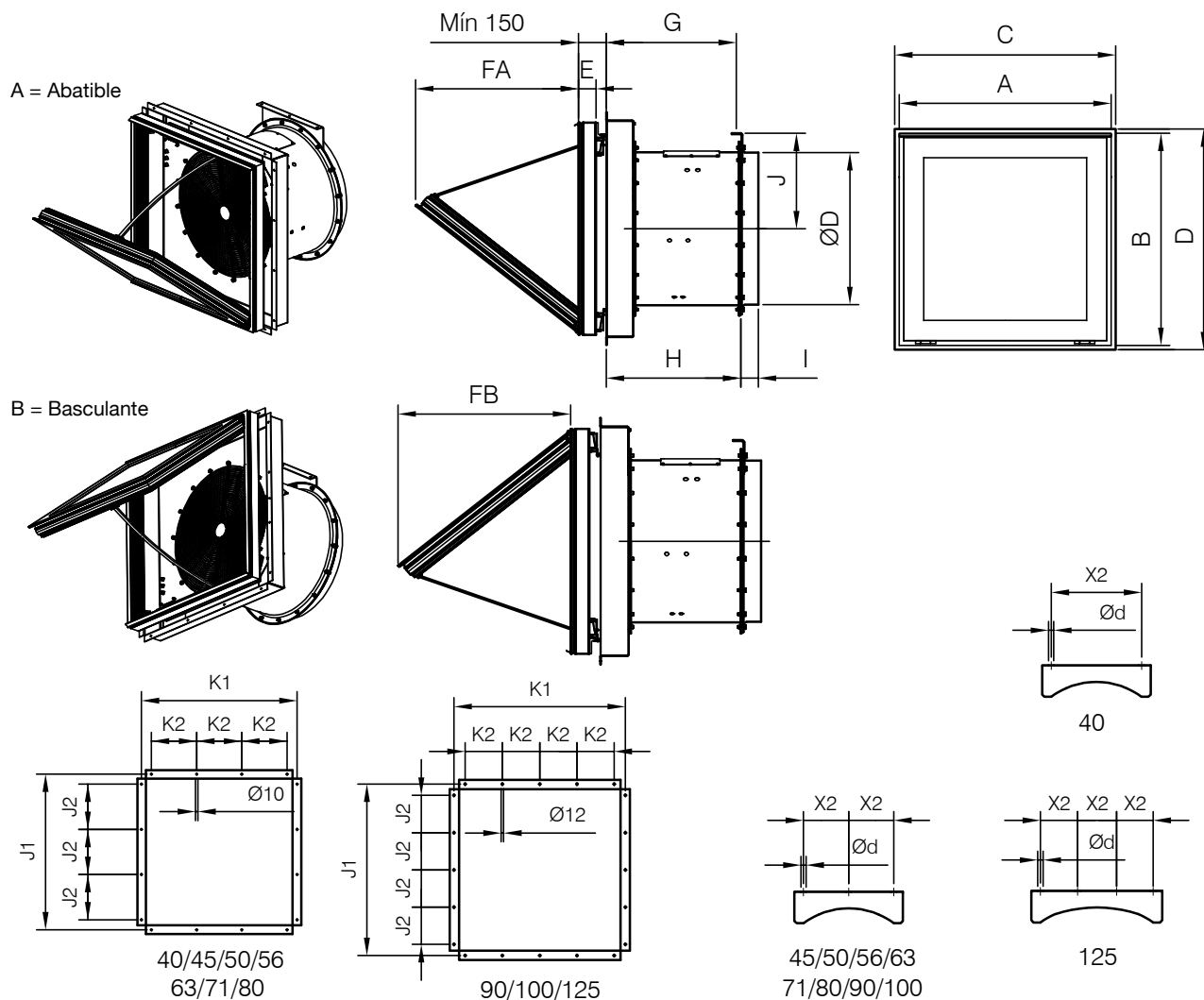

	A	B	C	D	ØD*	I	J	H	G	E	FA	FB	J1	J2	K1	K2	X2	Ød
WALL/DUCT-40	640	590	650	600	400	80	255	450	430	82	460	460	740	200	740	200	200	10
WALL/DUCT-45	640	590	650	600	450	80	280	490	470	82	460	460	740	200	740	200	200	12
WALL/DUCT-50	690	690	700	700	500	80	305	490	470	82	551	551	830	220	830	220	200	12
WALL/DUCT-56	690	690	700	700	560	80	340	530	510	82	551	551	830	220	830	220	215	13
WALL/DUCT-63	990	990	1000	1000	630	80	385	560	540	82	875	875	1090	300	1090	300	215	13
WALL/DUCT-71	990	990	1000	1000	710	80	445	630	605	82	875	875	1090	300	1090	300	225	13
WALL/DUCT-80	990	990	1000	1000	800	100	490	630	605	82	875	875	1090	300	1090	300	280	13
WALL/DUCT-90	1190	1190	1200	1200	900	100	550	630	605	82	922	922	1310	250	1310	250	280	18
WALL/DUCT-100	1190	1190	1200	1200	1000	100	600	730	705	82	922	922	1310	250	1310	250	280	18
WALL/DUCT-100-4T-15	1190	1190	1200	1200	1000	100	600	830	805	82	922	922	1310	250	1310	250	280	18
WALL/DUCT-100-4T-20	1190	1190	1200	1200	1000	100	600	830	805	82	922	922	1310	250	1310	250	280	18
WALL/DUCT-125	1490	1490	1500	1500	1250	100	725	1045	1025	82	1176	955	1660	300	1660	300	300	18
WALL/DUCT-125-4T/6-20	1490	1490	1500	1500	1250	100	725	845	825	82	1176	955	1660	300	1660	300	300	18
WALL/DUCT-125-4T/6-50	1490	1490	1500	1500	1250	100	725	1145	1125	82	1176	955	1660	300	1660	300	300	18
WALL/DUCT-125-4T/9-50	1490	1490	1500	1500	1250	100	725	1145	1125	82	1176	955	1660	300	1660	300	300	18
WALL/DUCT-125-4T/12-50	1490	1490	1500	1500	1250	100	725	1145	1125	82	1176	955	1660	300	1660	300	300	18
WALL/DUCT-125-6T/6-5.5	1490	1490	1500	1500	1250	100	725	845	825	82	1176	955	1660	300	1660	300	300	18
WALL/DUCT-125-6T/6-10	1490	1490	1500	1500	1250	100	725	845	825	82	1176	955	1660	300	1660	300	300	18
WALL/DUCT-125-6T/6-15	1490	1490	1500	1500	1250	100	725	845	825	82	1176	955	1660	300	1660	300	300	18
WALL/DUCT-125-6T/6-20	1490	1490	1500	1500	1250	100	725	845	825	82	1176	955	1660	300	1660	300	300	18
WALL/DUCT-125-6T/9-10	1490	1490	1500	1500	1250	100	725	845	825	82	1176	955	1660	300	1660	300	300	18

* Diámetro nominal tubería recomendada.
(C x D) Dimensión nominal de apertura de pared.
FA es la apertura cuando la compuerta es abatible.
FB es la apertura cuando la compuerta es basculante.

Curvas características

Q= Caudal en m³/h, m³/s y cfm

Pe= Presión estática en mmH₂O, Pa e inwg

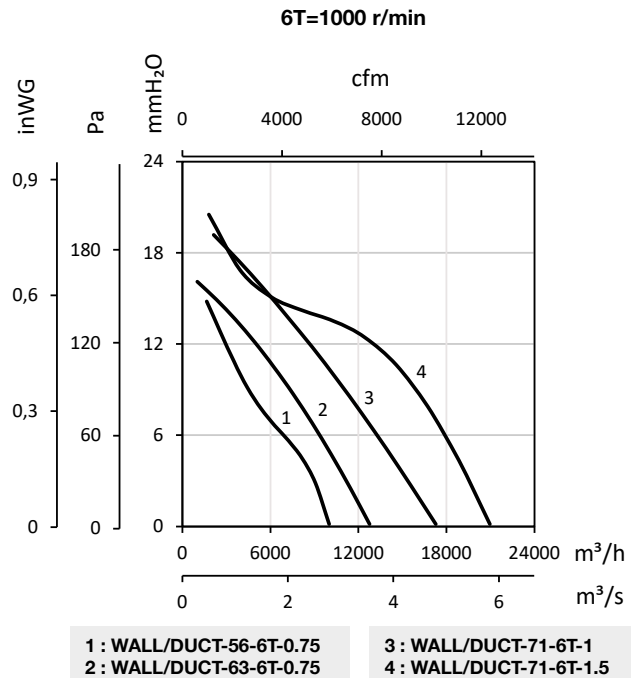
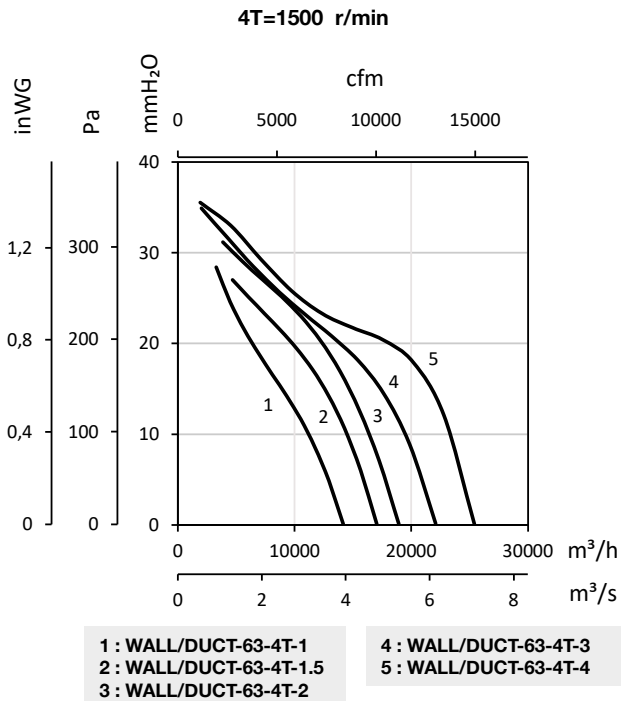
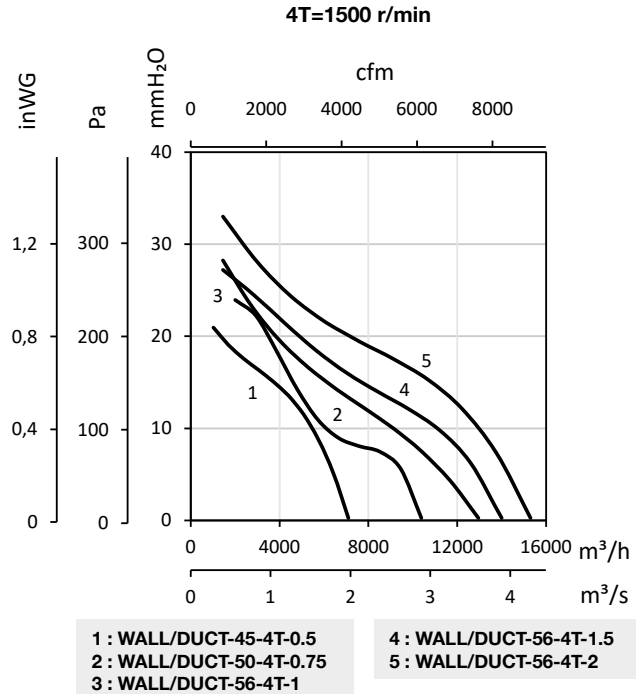
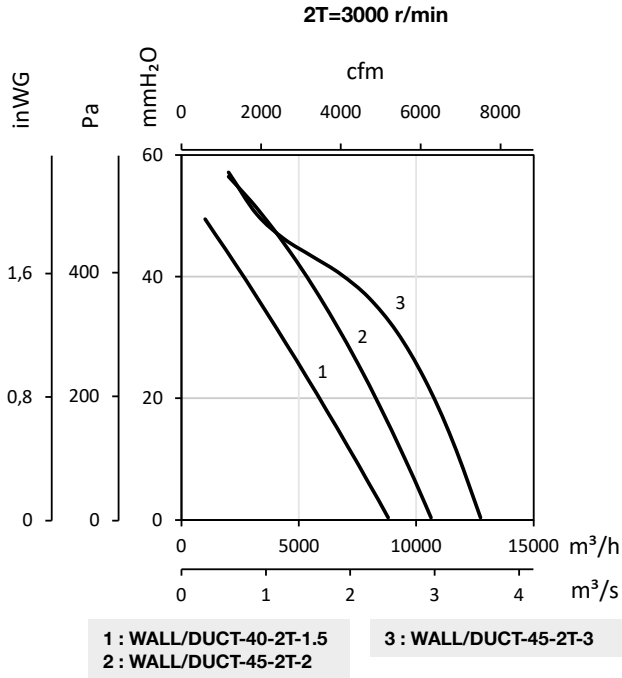

Curvas características

Q= Caudal en m³/h, m³/s y cfm

Pe= Presión estática en mmH₂O, Pa e inwg

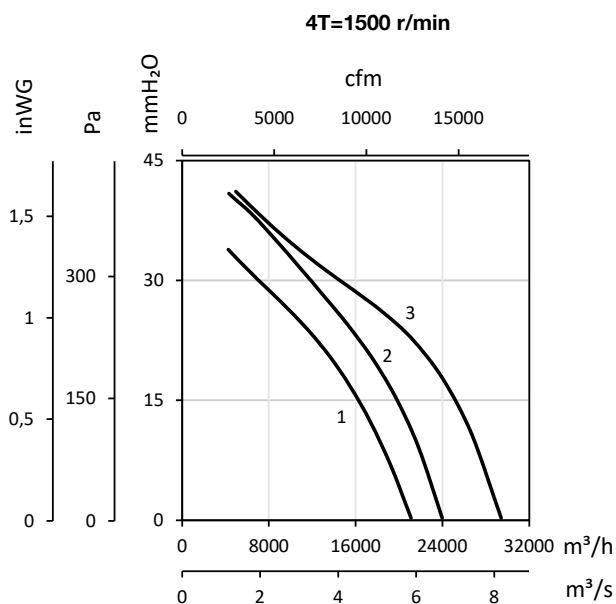

1 : WALL/DUCT-71-4T-2
2 : WALL/DUCT-71-4T-3

3 : WALL/DUCT-71-4T-4

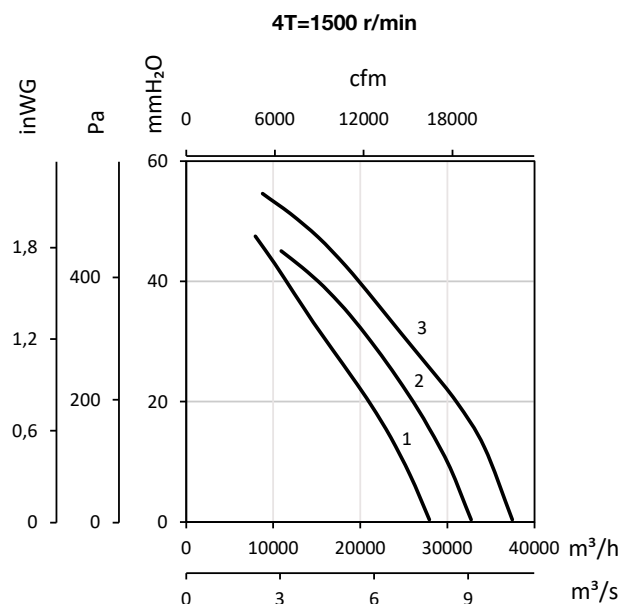

1 : WALL/DUCT-80-4T-3
2 : WALL/DUCT-80-4T-4

3 : WALL/DUCT-80-4T-5.5

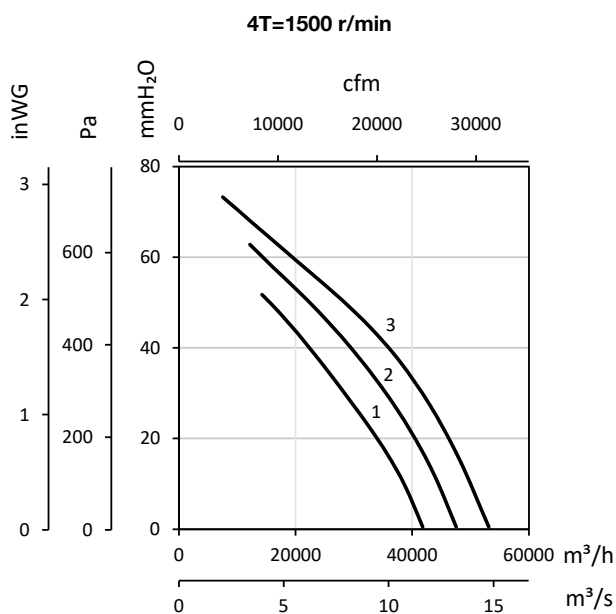

1 : WALL/DUCT-90-4T-5.5
2 : WALL/DUCT-90-4T-7.5

3 : WALL/DUCT-90-4T-10

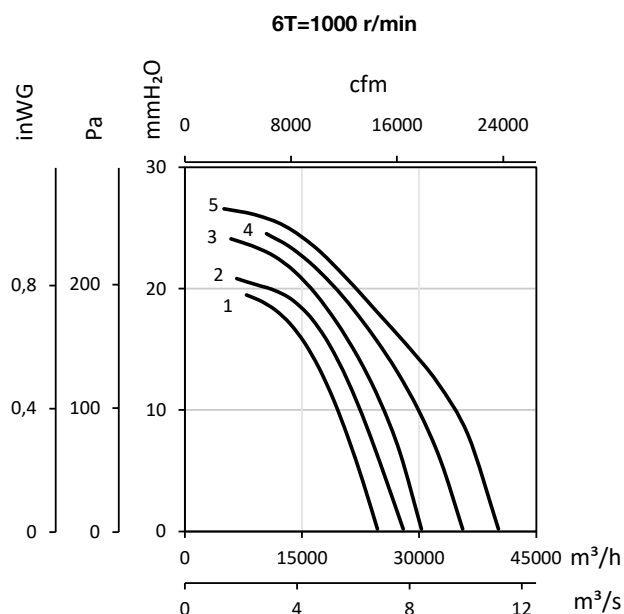

1 : WALL/DUCT-80-6T-1.5
2 : WALL/DUCT-80-6T-2
3 : WALL/DUCT-90-6T-2

4 : WALL/DUCT-90-6T-3
5 : WALL/DUCT-90-6T-4

Curvas características

Q= Caudal en m³/h, m³/s y cfm

Pe= Presión estática en mmH₂O, Pa e inwg

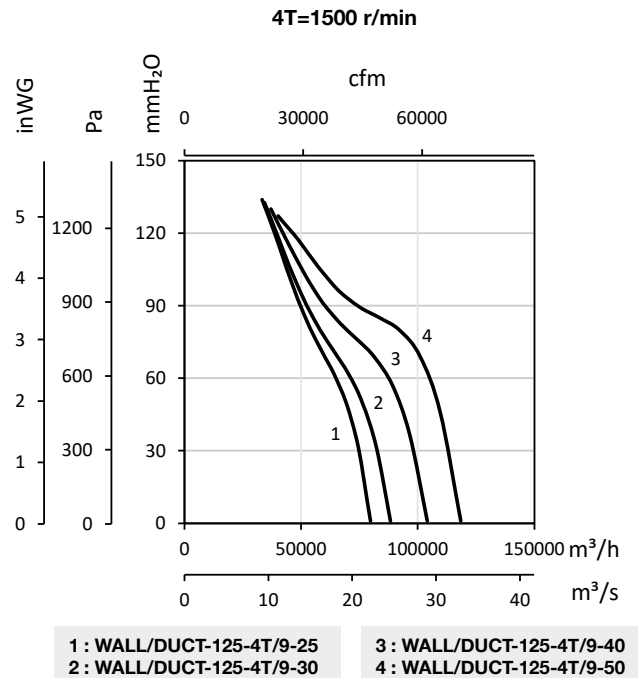
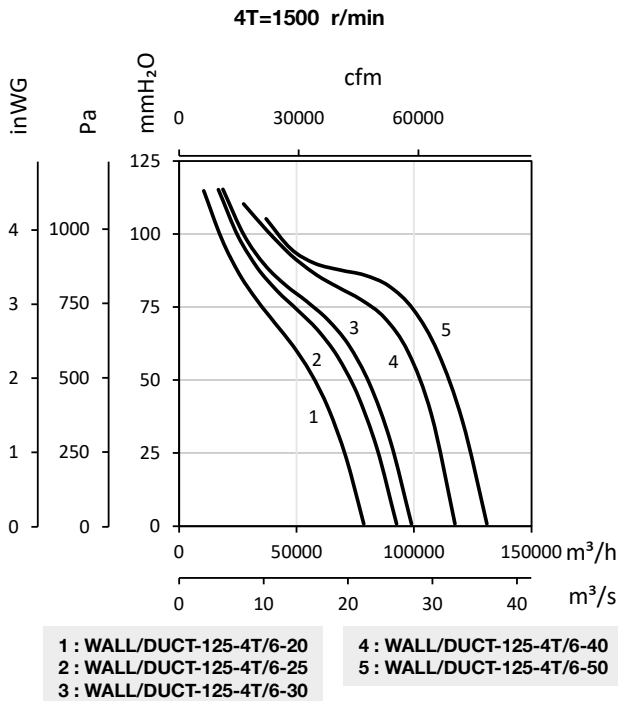
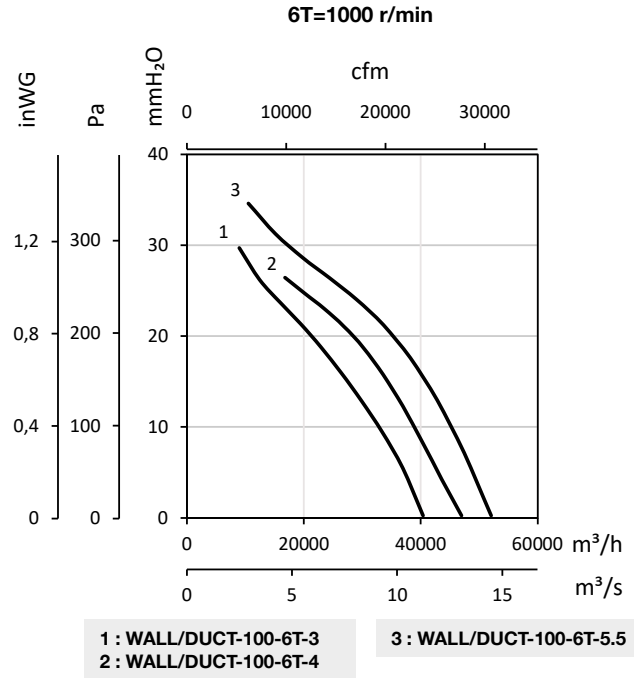
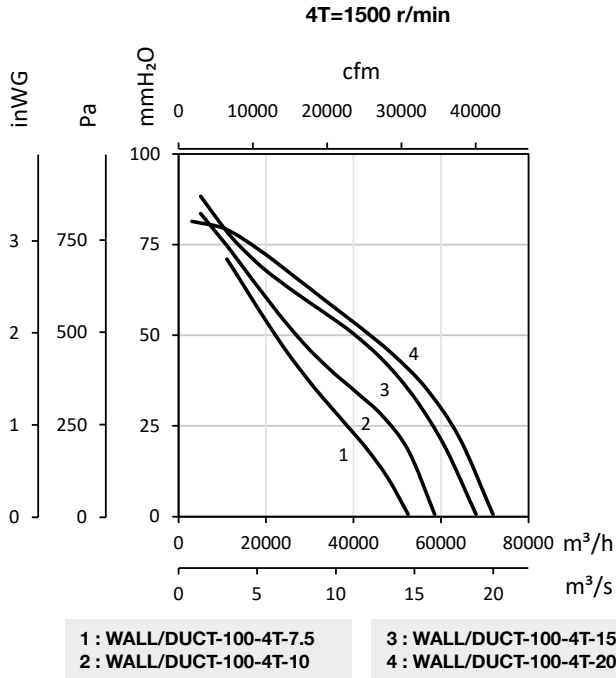

Curvas características

Q= Caudal en m³/h, m³/s y cfm

Pe= Presión estática en mmH₂O, Pa e inwg

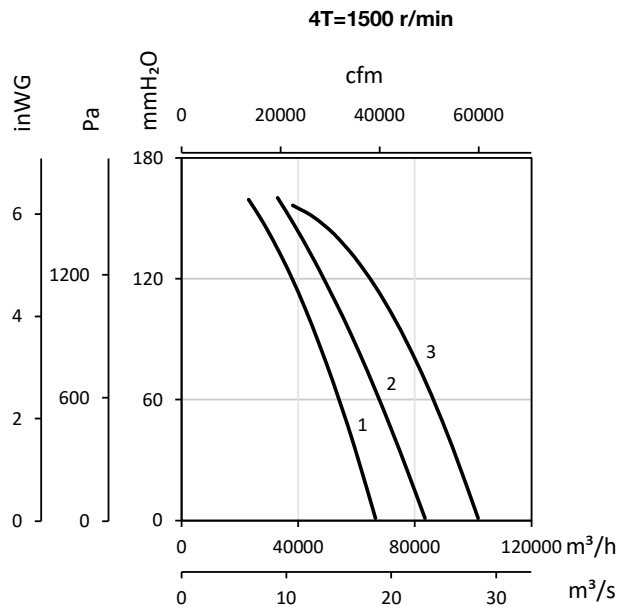

1 : WALL/DUCT-125-4T/12-30
2 : WALL/DUCT-125-4T/12-40

3 : WALL/DUCT-125-4T/12-50

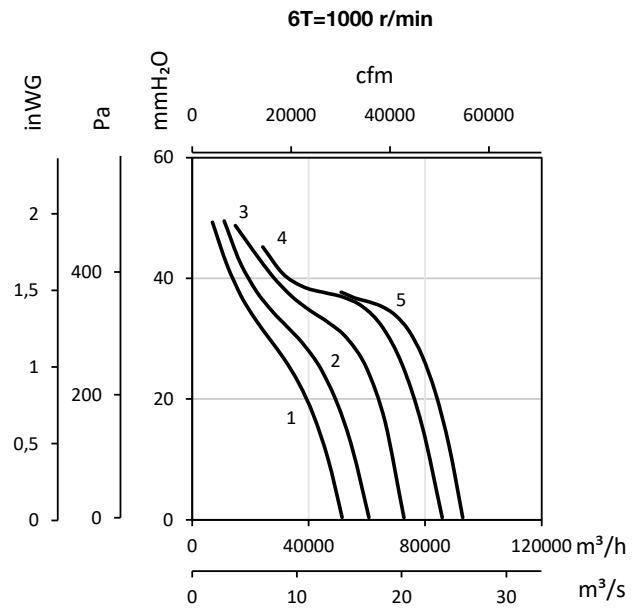

1 : WALL/DUCT-125-6T/6-5.5
2 : WALL/DUCT-125-6T/6-7.5
3 : WALL/DUCT-125-6T/6-10

4 : WALL/DUCT-125-6T/6-15
5 : WALL/DUCT-125-6T/6-20

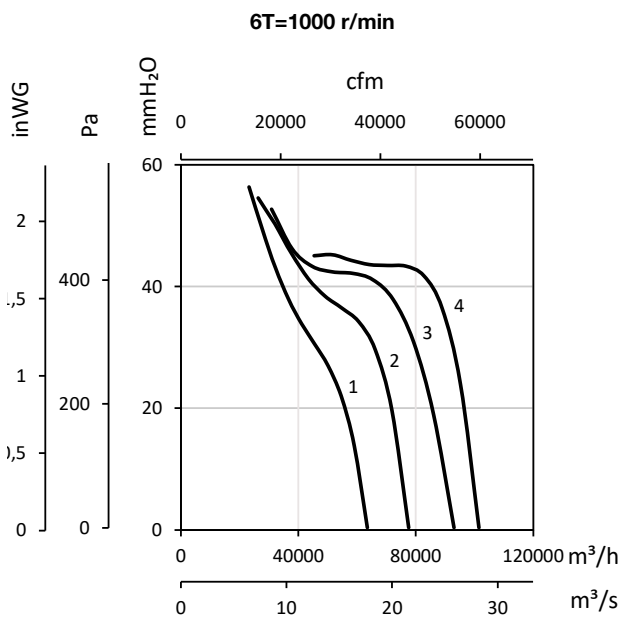

1 : WALL/DUCT-125-6T/9-10
2 : WALL/DUCT-125-6T/9-15

3 : WALL/DUCT-125-6T/9-20
4 : WALL/DUCT-125-6T/9-25

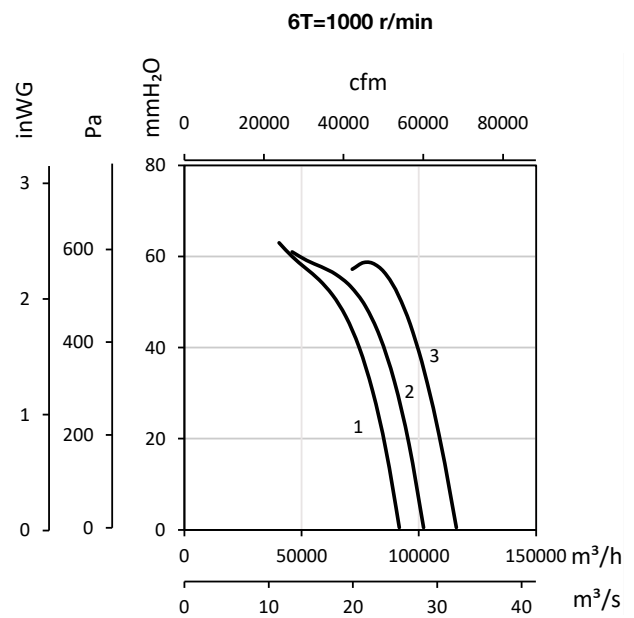

1 : WALL/DUCT-125-6T/12-25
2 : WALL/DUCT-125-6T/12-30

3 : WALL/DUCT-125-6T/12-40