

CVT/EC

400 °C/2h centrifugal roof fans with vertical air outlet and EC Technology IE5 motor



EC TECHNOLOGY MOTOR with integrated electronics



EC CONTROL Supplied as an optional accessory

Centrifugal roof fans with vertical air outlet and aluminum hood, equipped with EC Technology IE5 motor with integrated electronics.

Fan:

- Support base in galvanised steel sheet.
- Backward curved impeller made of galvanised sheet steel.
- Bird protection grid.
- Aluminum rain cover.
- Approved in accordance with standard EN 12101-3, with certificate no.: 0370-CPR-7365.
- Maximum temperature of air to be carried: -25 °C +120 °C.

Motor:

- High efficiency EC Technology motors with integrated electronics, regulated by 0-10 V or 4-20 mA.
- IE5 efficiency motors, class F and IP55 protection.
- Single-phase 220-277 V 50/60 Hz and three-phase 380-480 V 50/60 Hz.
- Working temperature: -25 °C +60 °C.
- Built-in control with fire mode function.

EC CONTROL:

Supplied as an optional accessory. Control panel for ventilation systems with EC Technology motors with the electronics integrated in the motor itself. With the following characteristics:

- CPC: Constant pressure control.
- CFC: Constant flow control.
- DAY/NIGHT: Double pressure setpoint adjustment according to time of day.
- External sensor: Compatible with temperature, humidity, air quality or CO sensor.
- Equipment preconfigured in constant pressure mode with 100 Pa set point.

Finish:

- Galvanised steel sheet and aluminum.



Support for roof-mounting



Order code

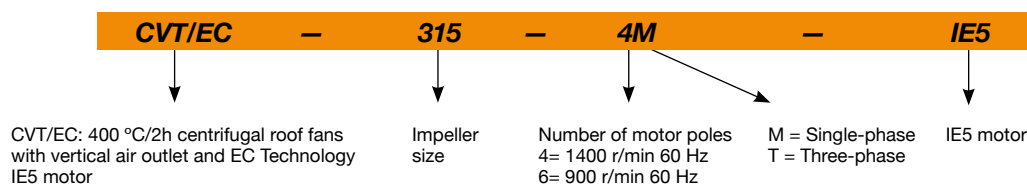

Technical characteristics

Model	Speed (r/min)		Maximum admissible current (A)		Installed power (kW)	Maximum flow rate (m³/h)	Sound pressure level dB (A)		Approx. weight (Kg)
	min	max.	230V	400V			Inlet	Exhaust	
CVT/EC-250-4M-IE5	200	1380	2.30		0.25	3100	44	49	34
CVT/EC-250-4T-IE5	200	1380		0.51	0.25	3100	44	49	33
CVT/EC-315-4M-IE5	200	1420	4.80		0.55	4950	47	53	39
CVT/EC-315-4T-IE5	200	1420		1.10	0.55	4950	47	53	38
CVT/EC-400-4M-IE5	200	1420	5.80		0.75	7000	54	60	57
CVT/EC-400-4T-IE5	200	1420		1.49	0.75	7000	54	60	54
CVT/EC-400-6M-IE5	200	900	5.80		0.75	4500	43	49	57
CVT/EC-400-6T-IE5	200	900		1.49	0.75	4500	43	49	54
CVT/EC-450-4T-IE5	200	1440		2.91	1.50	10200	58	63	71
CVT/EC-450-6T-IE5	200	900		1.49	0.75	6720	46	53	74
CVT/EC-500-6T-IE5	200	900		2.91	1.50	11460	50	55	109

1. Sound pressure level in dB(A) at a distance of 6 m and at maximum flow rate.



Erp. (Energy Related Products)

Information on Directive 2009/125/EC can be downloaded from the SODECA website or the QuickFan selector programme.

Acoustic characteristics

The values given are obtained under laboratory conditions according to ISO 3744.

Sound power spectrum $L_w(A)$ in dB(A) per Hz frequency band

Values measured at inlet with maximum flow rate (Q_{max})

	63	125	250	500	1000	2000	4000	8000
250-4	48	57	62	62	66	65	58	52
315-4	52	58	64	64	67	70	61	55
400-4	59	65	71	71	74	77	68	62
400-6	48	54	60	60	63	66	57	51
450-4	64	71	76	76	80	79	72	67
450-6	52	59	64	64	68	67	60	55
500-6	56	62	67	68	72	71	64	57

Values measured at exhaust with maximum flow rate (Q_{max})

	63	125	250	500	1000	2000	4000	8000
250-4	46	55	65	69	72	69	62	56
315-4	51	63	71	73	74	74	66	58
400-4	58	70	78	80	81	81	73	65
400-6	47	59	67	69	70	70	62	54
450-4	62	74	82	84	85	82	75	67
450-6	52	64	72	74	75	72	65	57
500-6	52	66	74	78	77	74	68	62

Dimensions mm

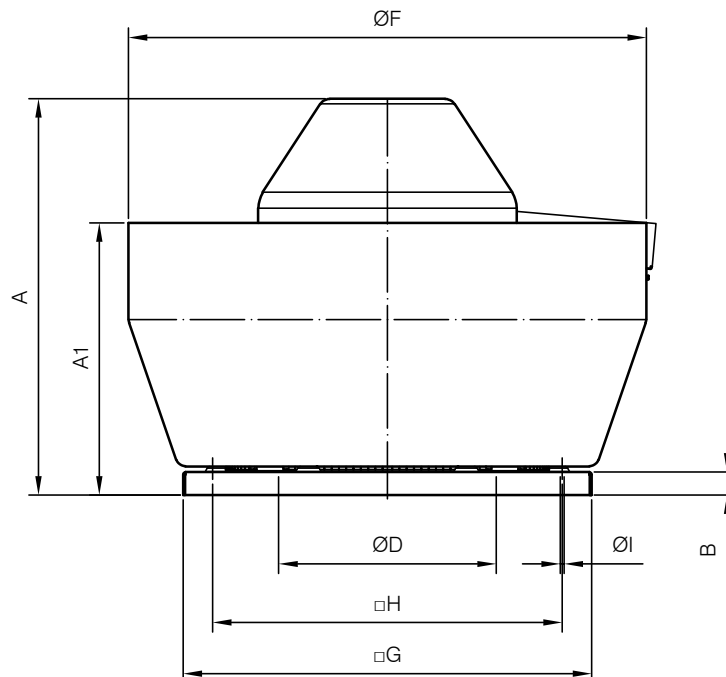

	A	A1	B	ØD*	ØF	G	H	ØI
CVT/EC-250	562	248	30	355	700	560	450	12
CVT/EC-315	592	373	30	355	700	560	450	12
CVT/EC-400	669	473	40	500	900	710	590	12
CVT/EC-450	685	474	40	500	900	710	590	12
CVT/EC-500	752	545	40	630	1100	900	750	14

* Recommended nominal tube diameter

Characteristic curves

Q= Flow rate in m³/h, m³/s and cfm

Pe= Static pressure in mm H₂O, Pa and inWG

W= Mechanical power

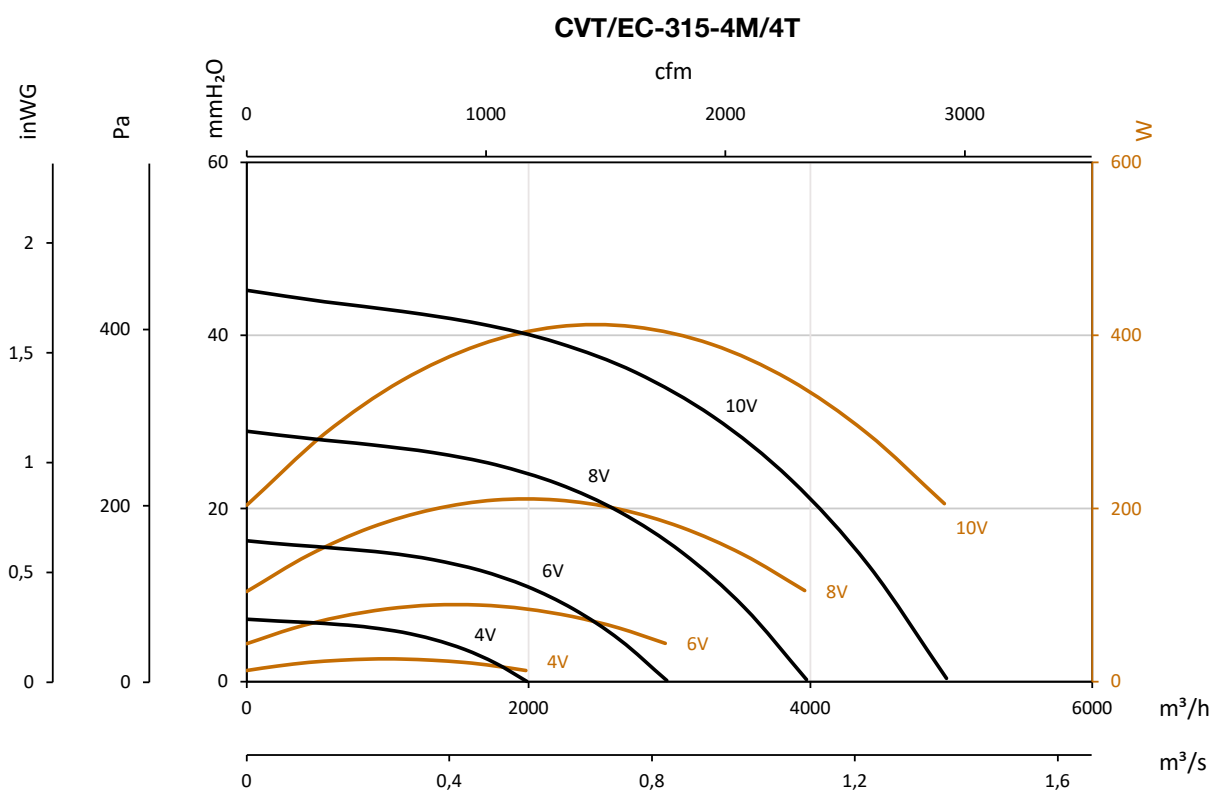
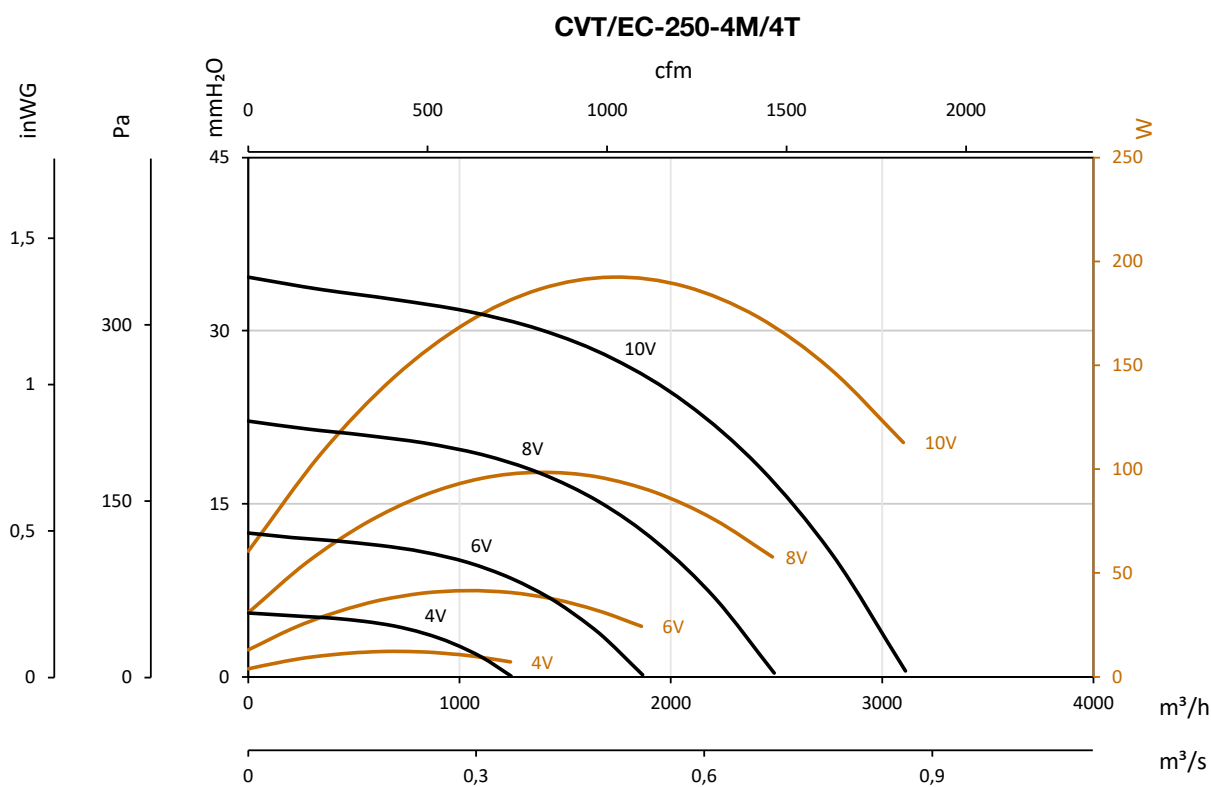

Characteristic curves

Q= Flow rate in m³/h, m³/s and cfm

Pe= Static pressure in mm H₂O, Pa and inWG

W= Mechanical power

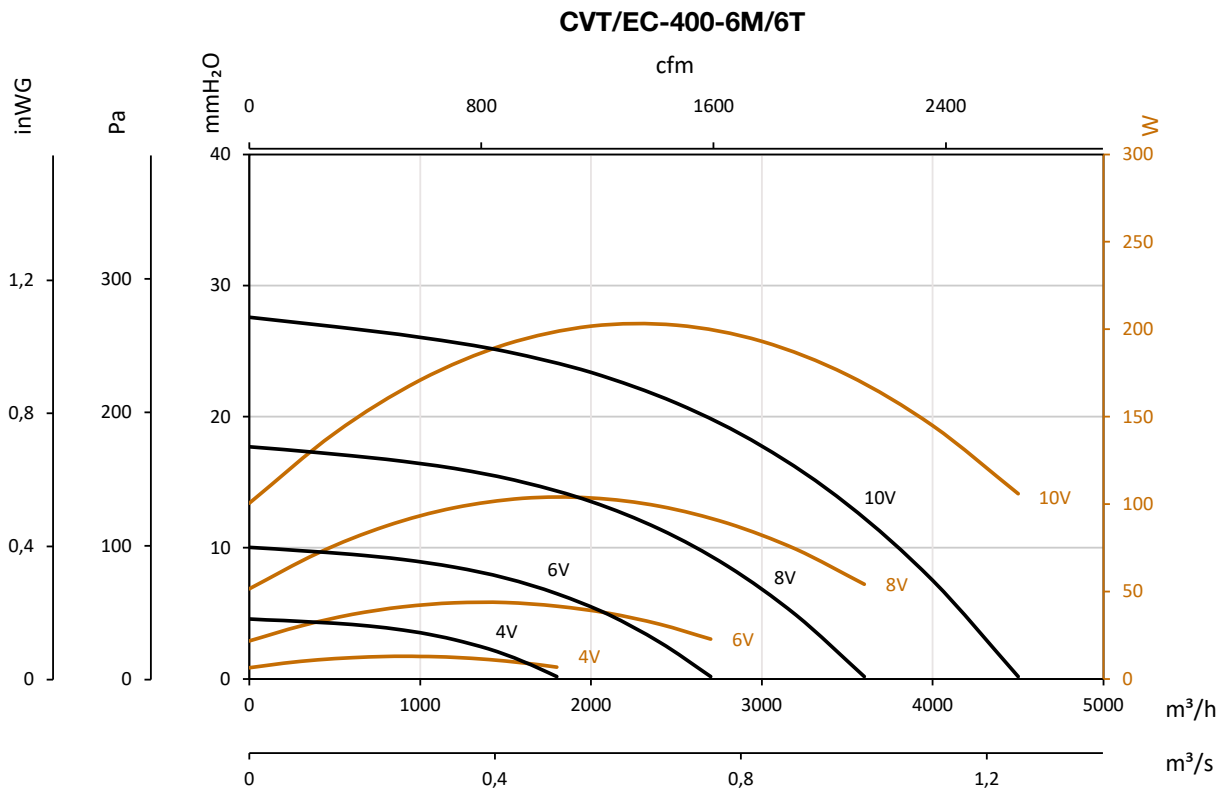
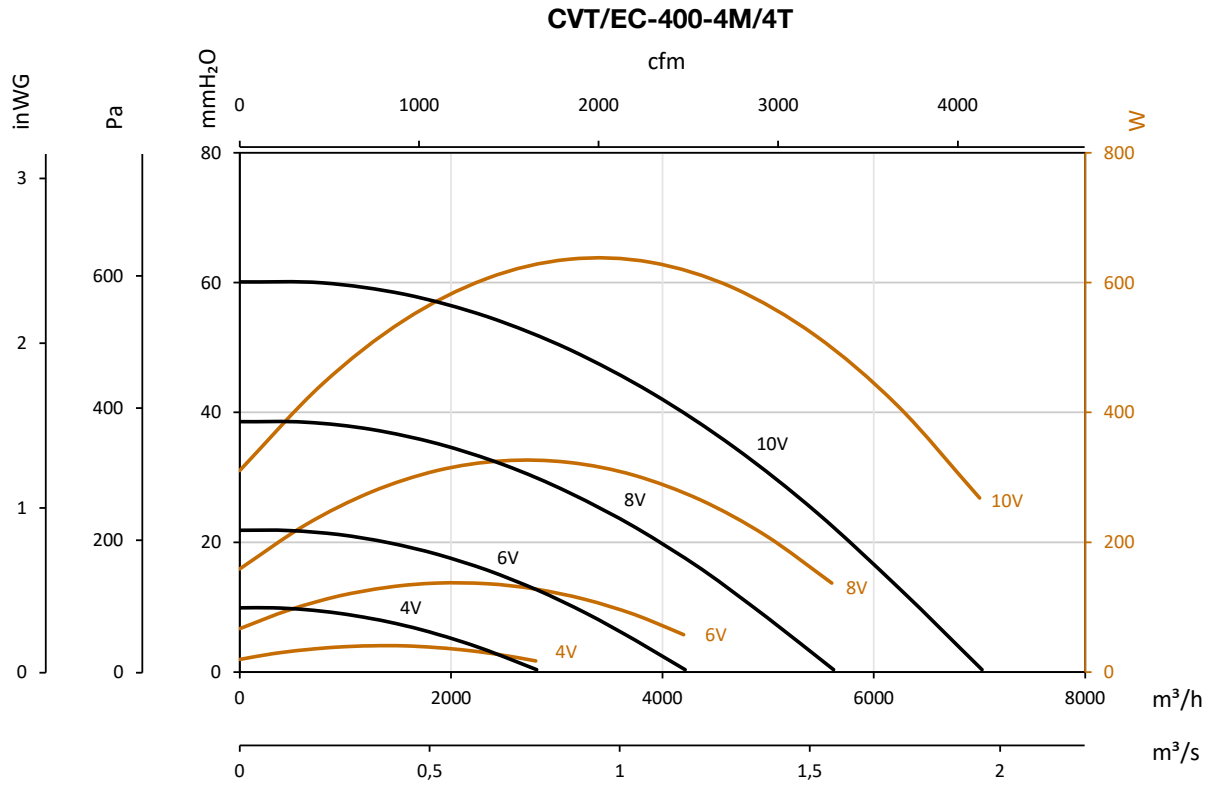

Characteristic curves

Q= Flow rate in m³/h, m³/s and cfm

Pe= Static pressure in mm H₂O, Pa and inWG

W= Mechanical power

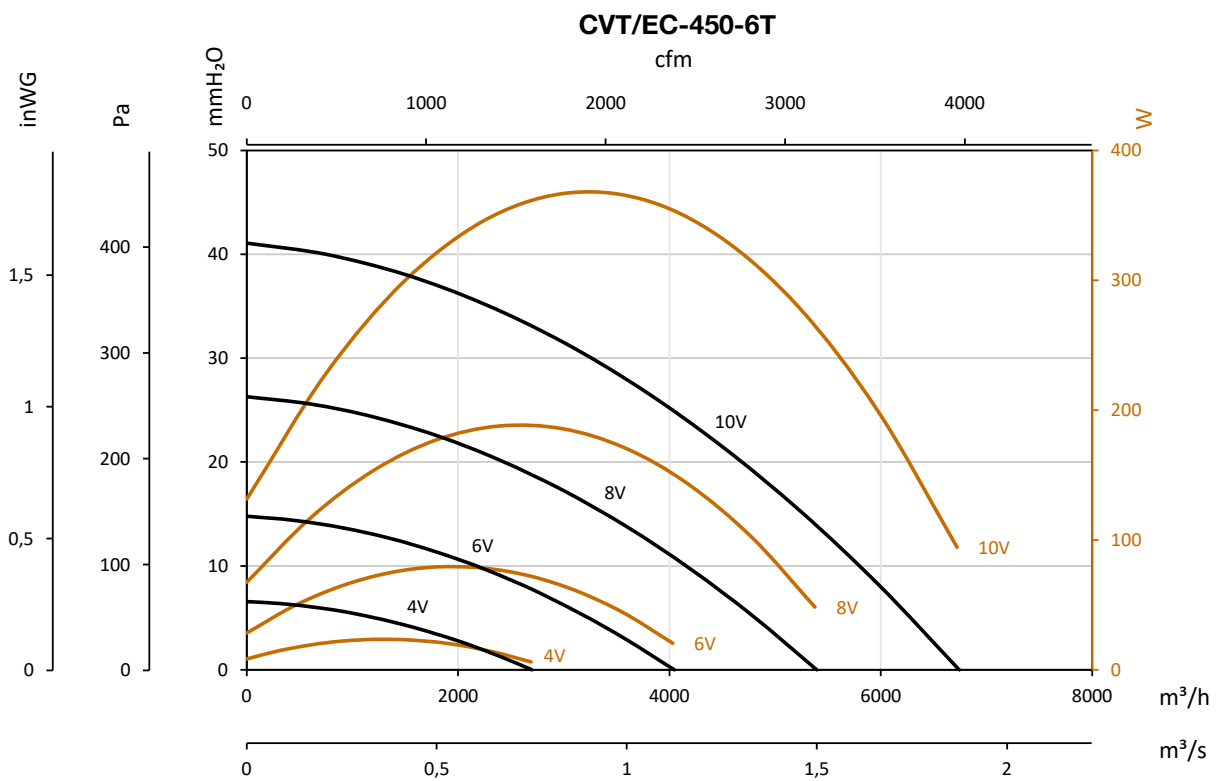
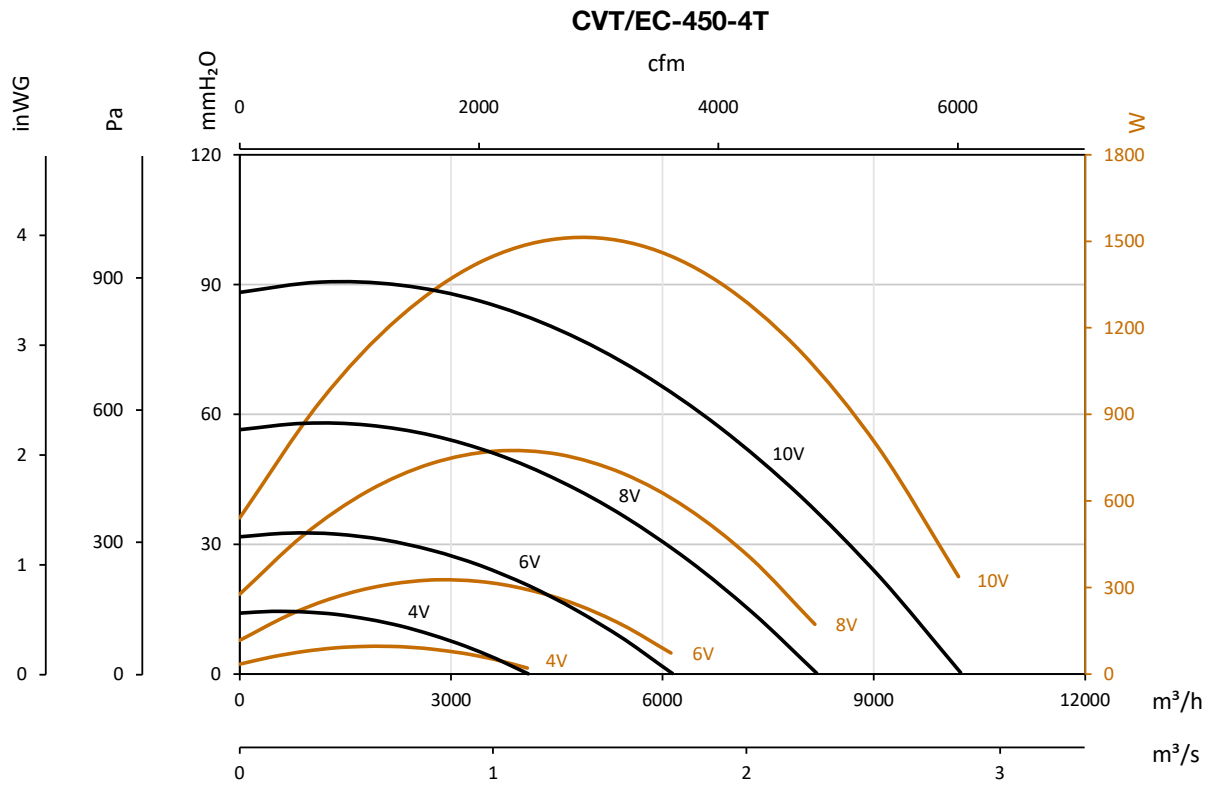

Characteristic curves

Q= Flow rate in m³/h, m³/s and cfm

Pe= Static pressure in mm H₂O, Pa and inwg

W= Mechanical power

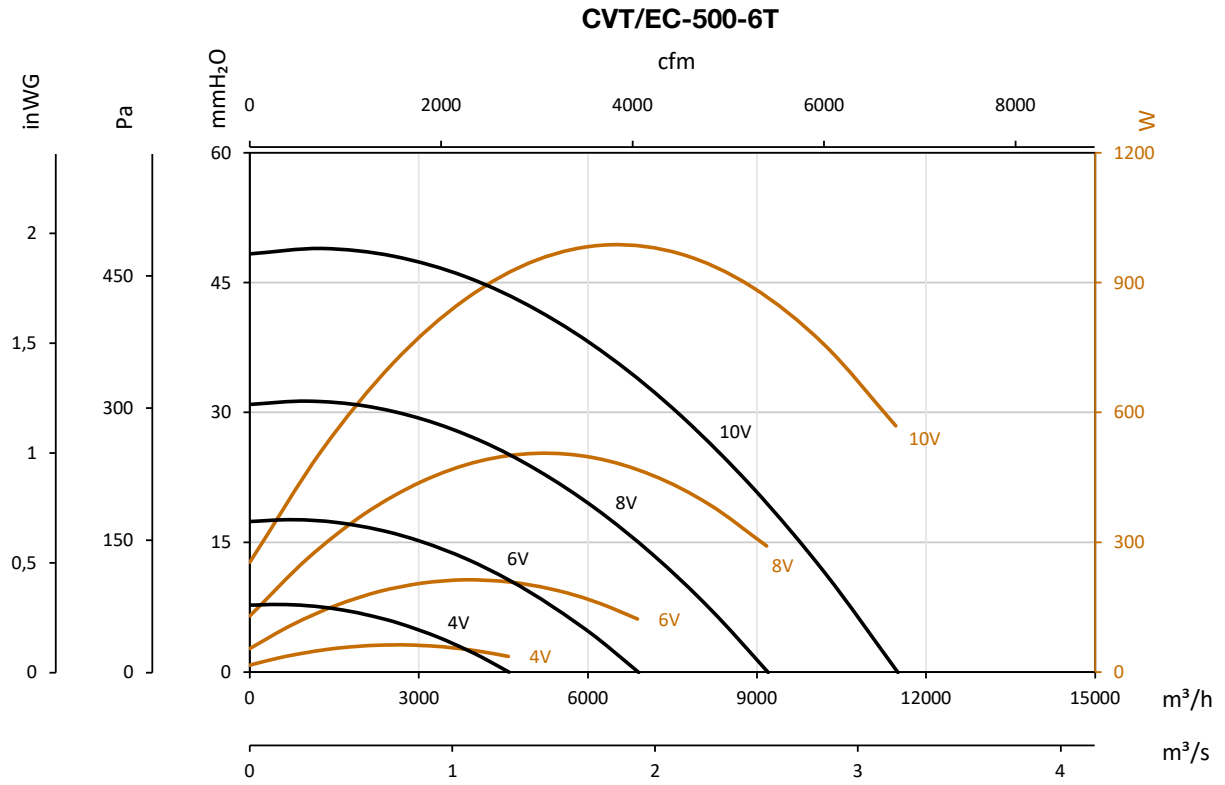

Accessories

