

# TCMP CJMP



TCMP



CJMP

## Extractores centrífugos y unidades de extracción 400°C/2h, con turbina multipala

TCMP: Extractores centrífugos 400°C/2h, para trabajar en el exterior de la zona de riesgo de incendios, de simple aspiración

CJMP: Unidades de extracción 400°C/2h con caja aislada acústicamente, para trabajar en el exterior de la zona de riesgo de incendios, de simple aspiración

### Ventilador:

- Envoltente en chapa de acero
- Turbina con álabes hacia delante, en chapa de acero galvanizado
- Homologación según norma EN 12101-3:2002/AC:2006, con certificación N°: 0370-CPR-0313 (TCMP), N°: 0370-CPR-0402 (CJMP)

### Motor:

- Motores clase F, con rodamientos a bolas, protección IP55
- Trifásicos 230/400V.-50Hz.(hasta 5,5CV) y 400/690V.-50Hz.(potencias superiores a 5,5CV)
- Temperatura máxima del aire a transportar: Servicio S1 -20°C+ 250°C en continuo, Servicio S2 200°C/2h, 300°C/2h y 400°C/2h

### Acabado:

- Anticorrosivo en resina de poliéster polimerizada a 190 °C, previo desengrase con tratamiento nanotecnológico libre de fosfatos.
- CJMP: Anticorrosivo en chapa de acero galvanizado

### Bajo demanda:

- Extractores con motor de 2 velocidades
- Extractores a transmisión



## Código de pedido

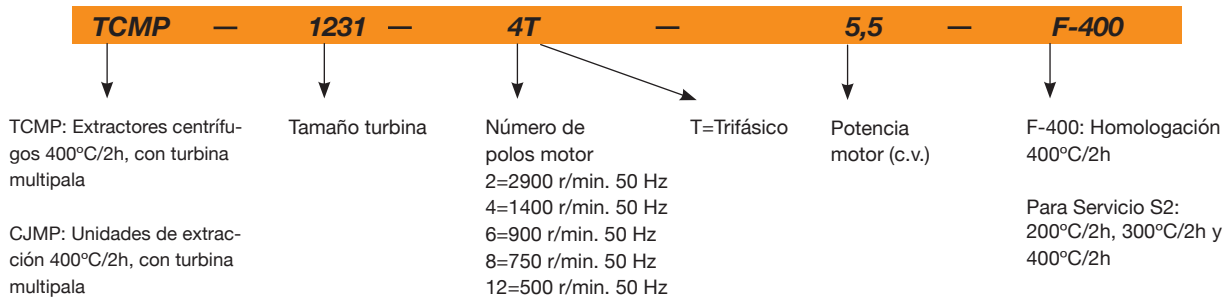

## Características técnicas

Modelo	Velocidad (r/min)	Intensidad máxima admisible (A)			Potencia instalada (kW)	Caudal máximo (m³/h)	Nivel presión sonora dB(A)		Peso aprox. (Kg)	
		230V	400V	690V			TCMP	CJMP	TCMP	CJMP
TCMP CJMP 820-4T	1350	1,66	0,96		0,25	1665	65	59	11	25
TCMP CJMP 922-4T	1380	2,92	1,69		0,55	2450	66	60	20	55
TCMP CJMP 1025-4T-1,5	1400	4,03	2,32		1,10	3385	70	64	28	69
TCMP CJMP 1025-4T-2	1430	5,96	3,44		1,50	3650	72	66	31	72
TCMP CJMP 1128-4T-3	1445	8,36	4,83		2,20	5005	74	68	38	87
TCMP CJMP 1128-4T-4	1445	10,96	6,33		3,00	5450	75	69	41	90
TCMP CJMP 1128-6T	945	3,90	2,20		0,75	3300	60	55	30	79
TCMP CJMP 1231-4T-3	1445	8,36	4,83		2,20	4740	73	67	45	103
TCMP CJMP 1231-4T-4	1445	10,96	6,33		3,00	5910	75	69	48	106
TCMP CJMP 1231-4T-5,5	1440	14,10	8,12		4,00	6850	77	71	55	113
TCMP CJMP 1231-6T	955	6,42	3,71		1,50	5115	64	59	45	103
TCMP CJMP 1435-4T-4	1445	10,96	6,33		3,00	5395	76	70	55	126
TCMP CJMP 1435-4T-5,5	1440	14,10	8,12		4,00	6575	78	72	62	133
TCMP CJMP 1435-4T-7,5	1440		11,60	6,70	5,50	7940	80	74	72	143
TCMP CJMP 1435-4T-10	1455		14,20	8,20	7,50	9370	82	76	80	151
TCMP CJMP 1435-6T	955	9,30	5,30		2,20	6400	68	63	57	128
TCMP CJMP 1640-4T-5,5	1440	14,10	8,12		4,00	7000	77	71	81	151
TCMP CJMP 1640-4T-7,5	1440		11,60	6,70	5,50	8035	80	74	91	161
TCMP CJMP 1640-4T-10	1455		14,20	8,20	7,50	9710	82	76	99	169

**Características técnicas**

Modelo	Velocidad (r/min)	Intensidad máxima admisible (A)			Potencia instalada (kW)	Caudal máximo (m³/h)	Nivel presión sonora dB(A)		Peso aprox. (Kg)	
		230V	400V	690V			TCMP	CJMP	TCMP	CJMP
TCMP CJMP 1640-6T 955		9,30	5,30		2,20	8105	71	66	76	146
TCMP CJMP 1845-4T-7,5 1440			11,60	6,70	5,50	8000	82	76	100	181
TCMP CJMP 1845-4T-10 1455			14,20	8,20	7,50	10000	85	79	108	189
TCMP CJMP 1845-6T 955		9,30	5,30		2,20	7500	77	72	85	166
TCMP CJMP 2050-4T-10 1455			14,20	8,20	7,50	8975	83	77	130	233
TCMP CJMP 2050-4T-15 1460			20,20	11,66	11,00	12525	87	81	154	257
TCMP CJMP 2050-4T-20 1460			27,50	15,88	15,00	16500	89	83	166	269
TCMP CJMP 2050-6T 960		16,50	9,46		4,00	11000	79	74	125	228



**Erp. Características del punto de máxima eficiencia (BEP)**

<b>MC</b>	Categoría de medición	<b>ηe[%]</b>	Eficiencia
<b>EC</b>	Categoría de eficiencia	<b>N</b>	Grado de eficiencia
<b>S</b>	Estática	<b>[kW]</b>	Potencia eléctrica
<b>T</b>	Total	<b>[m³/h]</b>	Caudal
<b>VSD</b>	Variador de velocidad	<b>[mmH₂O]</b>	Presión estática o total (Según EC)
<b>SR</b>	Relación específica	<b>[RPM]</b>	Velocidad

Modelo	MC	EC	VSD	SR	ηe[%]	N	(kW)	(m³/h)	(mmH₂O)	(RPM)
820-4T	A	S	NO	1,00	35,2%	46,5	0,165	721	29,53	1441
922-4T	A	S	NO	1,00	36,4%	46,0	0,307	1187	34,59	1437
1025-4T-1,5	A	S	NO	1,01	38,9%	47,1	0,506	1501	48,06	1462
1025-4T-2	A	S	NO	1,01	35,3%	43,1	0,582	1541	48,88	1478
1128-4T-3	A	S	NO	1,01	40,5%	46,8	1,002	2303	64,68	1479
1128-4T-4	A	S	NO	1,01	40,2%	46,3	1,059	2370	65,85	1483
1128-6T	A	S	NO	1,00	36,8%	46,0	0,348	1622	28,94	981
1231-4T-3	A	S	NO	1,01	41,7%	46,9	1,482	2927	77,43	1469
1231-4T-4	A	S	NO	1,01	41,2%	46,2	1,613	3143	77,62	1475
1231-4T-5,5	A	S	NO	1,01	41,3%	46,2	1,653	3120	80,29	1478
1231-6T	A	S	NO	1,00	38,3%	46,1	0,579	2332	34,85	986
1435-4T-4	A	S	NO	1,01	42,4%	46,3	2,428	3916	96,46	1462
1435-4T-5,5	A	S	NO	1,01	42,4%	46,3	2,425	3865	97,59	1468
1435-4T-7,5	A	S	NO	1,01	42,5%	46,3	2,492	3904	99,52	1476
1435-4T-10	A	S	NO	1,01	42,5%	46,6	2,271	3629	97,61	1470
1435-6T	A	S	NO	1,01	39,6%	46,2	0,906	3441	38,22	985
1640-4T-5,5	A	S	NO	1,01	55,4%	58,7	3,000	4685	130,10	1461
1640-4T-7,5	A	S	NO	1,01	48,0%	50,6	3,899	5080	135,33	1463
1640-4T-10	A	S	NO	1,02	43,1%	45,2	4,596	5382	135,00	1476
1640-6T	A	S	NO	1,01	43,9%	49,5	1,300	3946	53,00	978
1845-4T-7,5	A	S	NO	1,02	57,0%	58,3	6,385	7900	169,13	1439
1845-4T-10	A	S	NO	1,02	56,7%	57,6	7,387	8599	178,87	1461
1845-6T	A	S	NO	1,01	47,0%	51,3	2,070	5546	64,33	965
2050-4T-10	A	S	NO	1,02	54,9%	55,4	8,393	8977	188,36	1455
2050-4T-15	A	S	NO	1,02	55,7%	56,0	9,285	9695	195,91	1470
2050-4T-20	B	T	NO	1,03	69,8%	69,5	16,819	16500	261,08	1459
2050-6T	A	S	NO	1,01	36,5%	39,0	3,988	6929	77,00	966

**Características acústicas**

Los valores indicados, se determinan mediante medidas de nivel de presión y potencia sonora en dB(A) obtenidas en campo libre a una distancia equivalente a dos veces la envergadura del ventilador más el diámetro de la turbina, con un mínimo de 1,5 mts.

Modelo CJMP	Espectro de potencia sonora Lw(A) en dB(A) por banda de frecuencia en Hz																
	63	125	250	500	1000	2000	4000	8000	Modelo CJMP	63	125	250	500	1000	2000	4000	8000
820	40	50	61	68	72	69	67	60	1435-4-4	54	63	74	81	85	83	81	74
922	41	51	62	69	73	70	68	61	1435-4-5,5	56	65	76	83	87	85	83	76
1025-4-1,5	45	55	66	73	77	74	72	65	1435-4-7,5	58	67	78	85	89	87	85	78
1025-4-2	47	57	68	75	79	76	74	67	1435-4-10	60	69	80	87	91	89	87	80
1128-4-3	49	59	70	77	81	78	76	69	1435-6	46	55	66	73	77	75	73	66
1128-4-4	50	60	71	78	82	79	77	70	1640-4-5,5	55	64	75	82	86	84	82	75
1128-6	35	45	56	63	67	64	62	55	1640-4-7,5	58	67	78	85	89	87	85	78
1231-4-3	51	60	71	78	82	80	78	71	1640-4-10	60	69	80	87	91	89	87	80
1231-4-4	53	62	73	80	84	82	80	73	1640-6	49	58	69	76	80	78	76	69
1231-4-5,5	55	64	75	82	86	84	82	75	1845-4-7,5	61	71	82	89	93	91	89	81
1231-6	42	51	62	69	73	71	69	62	1845-4-10	64	74	85	92	96	94	92	84

Características acústicas

1845-6	56	66	77	84	88	86	84	76	1435-4-4	48	57	68	75	79	77	75	68
2050-4-10	62	72	83	90	94	92	90	82	1435-4-5,5	50	59	70	77	81	79	77	70
2050-4-15	66	76	87	94	98	96	94	86	1435-4-7,5	52	61	72	79	83	81	79	72
2050-4-20	68	78	89	96	100	98	96	88	1435-4-10	54	63	74	81	85	83	81	74
2050-6	58	68	79	86	90	88	86	78	1435-6	41	50	61	68	72	70	68	61
820	34	44	55	62	66	63	61	54	1640-4-5,5	49	58	69	76	80	78	76	69
922	35	45	56	63	67	64	62	55	1640-4-7,5	52	61	72	79	83	81	79	72
1025-4-1,5	39	49	60	67	71	68	66	59	1640-4-10	54	63	74	81	85	83	81	74
1025-4-2	41	51	62	69	73	70	68	61	1640-6	44	53	64	71	75	73	71	64
1128-4-3	43	53	64	71	75	72	70	63	1845-4-7,5	55	65	76	83	87	85	83	75
1128-4-4	44	54	65	72	76	73	71	64	1845-4-10	58	68	79	86	90	88	86	78
1128-6	30	40	51	58	62	59	57	50	1845-6	51	61	72	79	83	81	79	71
1231-4-3	45	54	65	72	76	74	72	65	2050-4-10	56	66	77	84	88	86	84	76
1231-4-4	47	56	67	74	78	76	74	67	2050-4-15	60	70	81	88	92	90	88	80
1231-4-5,5	49	58	69	76	80	78	76	69	2050-4-20	62	72	83	90	94	92	90	82
1231-6	37	46	57	64	68	66	64	57	2050-6	53	63	74	81	85	83	81	73

Dimensiones mm

Boca de aspiración

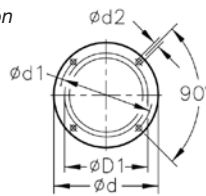

Boca de impulsión

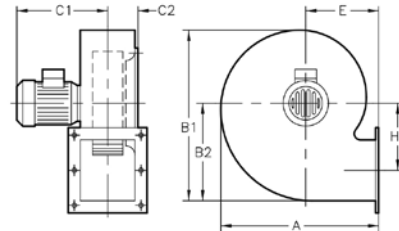
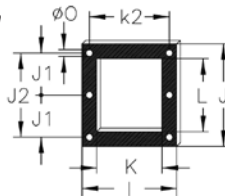

Modelo	A	B1	B2	C1	C2	ØD1*	Ød	Ød1	Ød2	E	H1	I	J	J1	J2	K	k2	L	Ø0
820-4T	322	377	223	272	68.5	200	247	230	M.6	137.5	137	184	213	94.5	189	130	160	156	9

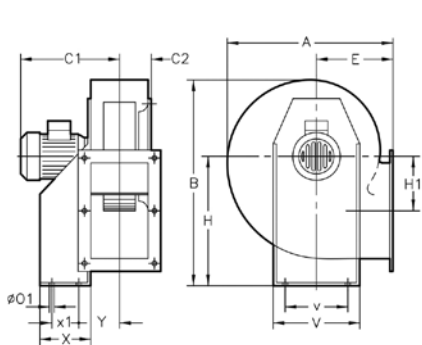

922/1025/1128/1231

Boca de aspiración

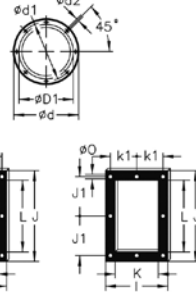

Boca de impulsión

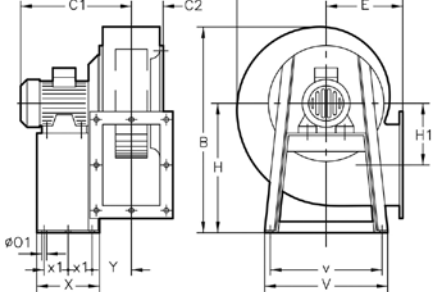

1435/1640/1845/2050

Modelo	A	B	C1	C2	ØD1*	Ød	Ød1	Ød2	E	H	H1	I	J	J1	K	k1	k2	L	Ø0	Ø01	V	v	X	x1	Y
922	388,5	455	332	73,5	224	278	256	M.8	180	280	134	204	282,5	128	140	-	180	215	9,5	10,5	290	220	114	50	105
1025	427	503	393	86	250	305	282	M.8	197	310	144	229	312,5	145	165	-	205	250	9,5	12,5	315	228	134	74	115,5
1128-4T	472	553	430	93,5	280	348	320	M.8	216	340	152	244	364	170	180	-	220	296,5	9,5	12,5	348	245	144	95	122,5
1128-6T	472	553	400	93,5	280	348	320	M.8	216	340	152	244	364	170	180	-	220	296,5	9,5	12,5	348	245	144	95	122,5
1231-3	526	630	440	103,5	315	382	354	M.8	238	390	179,5	264	382,5	180	200	-	240	320	11,5	13	382	322	183	140	126
1231-4	526	630	440	103,5	315	382	354	M.8	238	390	179,5	264	382,5	180	200	-	240	320	11,5	13	382	322	183	140	126
1231-5,5	526	630	463	103,5	315	382	354	M.8	238	390	179,5	264	382,5	180	200	-	240	320	11,5	13	382	322	183	140	126
1231-6T	526	630	440	103,5	315	382	354	M.8	238	390	179,5	264	382,5	180	200	-	240	320	11,5	13	382	322	183	140	126
1435-4	573,5	715	464	118	355	422	394	M.8	250	445	242,5	292	342,5	159	228	133	-	280	11,5	13	456	420	333	136,5	150
1435-5,5	573,5	715	477	118	355	422	394	M.8	250	445	242,5	292	342,5	159	228	133	-	280	11,5	13	456	420	333	136,5	150
1435-7,5	573,5	715	525	118	355	422	394	M.8	250	445	242,5	292	342,5	159	228	133	-	280	11,5	13	456	420	333	136,5	150
1435-10	573,5	715	525	118	355	422	394	M.8	250	445	242,5	292	342,5	159	228	133	-	280	11,5	13	456	420	333	136,5	150
1435-6T	573,5	715	487	118	355	422	394	M.8	250	445	242,5	292	342,5	159	228	133	-	280	11,5	13	456	420	333	136,5	150
1640-5,5	634	799	499	130	400	464	438	M.8	270	495	271	336	404	185	250	150	-	321	11,5	13	500	460	327	133,5	162,5
1640-7,5	634	799	537	130	400	464	438	M.8	270	495	271	336	404	185	250	150	-	321	11,5	13	500	460	327	133,5	162,5
1640-10	634	799	537	130	400	464	438	M.8	270	495	271	336	404	185	250	150	-	321	11,5	13	500	460	327	133,5	162,5
1640-6T	634	799	499	130	400	464	438	M.8	270	495	271	336	404	185	250	150	-	321	11,5	13	500	460	327	133,5	162,5
1845-4T	711	901	554	147	450	515	485	M.8	302	560	305	370	444	202	284	164	-	361	11,5	13	538	502	340	140	179,5
1845-6T	711	901	516	147	450	515	485	M.8	302	560	305	370	444	202	284	164	-	361	11,5	13	538	502	340	140	179,5
2050-10	797	987	572	162,5	500	565	535	M.10	345	610	313	411	544	250	315	182,5	-	451	11,5	13	635	615	435	188	196
2050-12,5	797	987	624	162,5	500	565	535	M.10	345	610	313	411	544	250	315	182,5	-	451	11,5	13	635	615	435	188	196
2050-15	797	987	677	162,5	500	565	535	M.10	345	610	313	411	544	250	315	182,5	-	451	11,5	13	635	615	435	188	196
2050-20	797	987	677	162,5	500	565	535	M.10	345	610	313	411	544	250	315	182,5	-	451	11,5	13	635	615	435	188	196
2050-6T	797	987	572	162,5	500	565	535	M.10	345	610	313	411	544	250	315	182,5	-	451	11,5	13	635	615	435	188	196

\* Diámetro nominal tubería recomendada

Dimensiones mm

Suministro standard impulsión:: LG-270

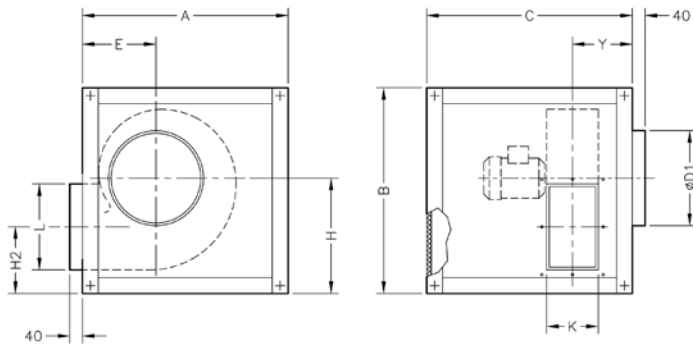

Detalle taladros boca impulsión

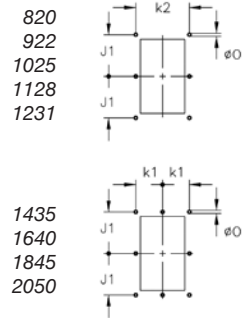

Modelo	A	B	C	ØD1	E	H	H2	K	L	Y
CJMP-820	400	450	450	200	142	263	126	130	156	112
CJMP-922	610	610	610	224	187	349	215	140	215	176
CJMP-1025	660	660	660	250	204	379	235	165	250	178.5
CJMP-1128	720	720	720	280	223	409	257	180	295	191
CJMP-1231	800	800	800	315	245	459	279.5	200	320	205
CJMP-1435	880	880	880	355	257	514	271.5	230	280	291
CJMP-1640	970	970	970	400	277	564	293	250	320	324
CJMP-1845	1070	1070	1070	450	309	629	324	284	360	357
CJMP-2050	1160	1160	1160	500	352	679	366	315	450	385.5

Modelo	k1	k2	J1	Ø0
CJMP-820	-	160	94.5	9
CJMP-922	-	180	128	9.5
CJMP-1025	-	205	145	9.5
CJMP-1128	-	220	170	9.5
CJMP-1231	-	240	180	11.5
CJMP-1435	133	-	159	11.5
CJMP-1640	150	-	185	11.5
CJMP-1845	164	-	202	11.5
CJMP-2050	182.5	-	250	11.5

Suministro bajo demanda: LG-0

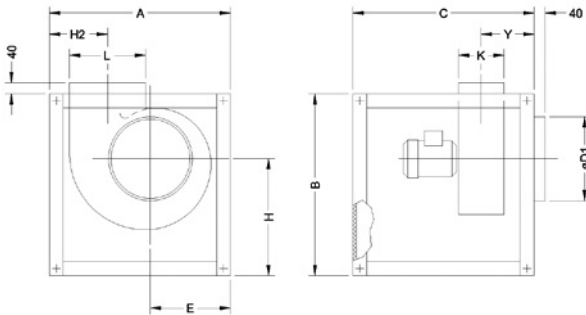

Modelo	A	B	C	ØD1	E	H	H2	K	L	Y
CJMP-922	610	610	610	224	279	349	197	140	215	176
CJMP-1025	660	660	660	250	302	379	214	165	250	178.5
CJMP-1128	720	720	720	280	335	409	233	180	295	191
CJMP-1231	800	800	800	315	366	459	255	200	320	205
CJMP-1435	880	880	880	355	385	514	253	230	280	291
CJMP-1640	970	970	970	400	412	564	287	250	320	324
CJMP-1845	1070	1070	1070	450	446	629	319	284	360	357
CJMP-2050	1160	1160	1160	500	485	679	362	315	450	383.5

Suministro bajo demanda: LG-90

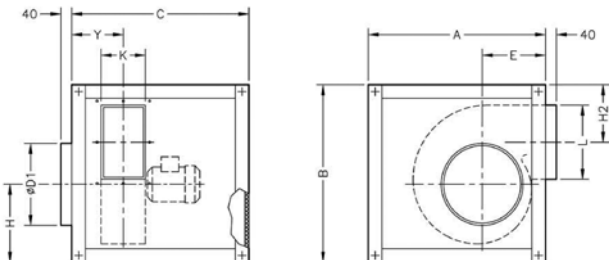

Modelo	A	B	C	ØD1	E	H	H2	K	L	Y
CJMP-922	720	720	720	224	187	349	237	140	215	176
CJMP-1025	800	800	800	250	204	379	277	165	250	178
CJMP-1128	880	880	880	280	223	409	319	180	295	191
CJMP-1231	970	970	970	315	245	459	332	200	320	205
CJMP-1435	1070	1070	1070	355	257	514	314	230	280	291
CJMP-1640	1160	1160	1160	400	277	564	325	250	320	325
CJMP-1845	865	1260	1050	450	309	629	326	284	360	357
CJMP-2050	965	1400	1200	500	352	679	408	315	450	383.5

## Curvas características

Q= Caudal en m<sup>3</sup>/h, m<sup>3</sup>/s y cfm.

Pe= Presión estática en mmH<sub>2</sub>O, Pa e inwg.

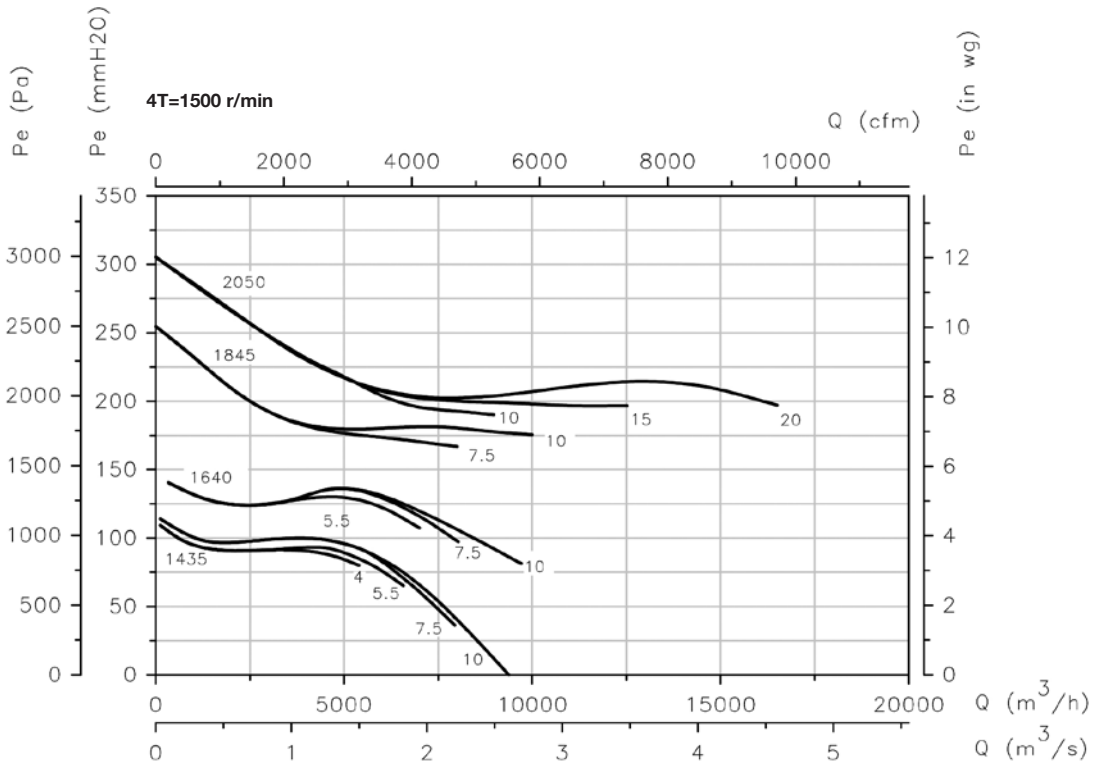
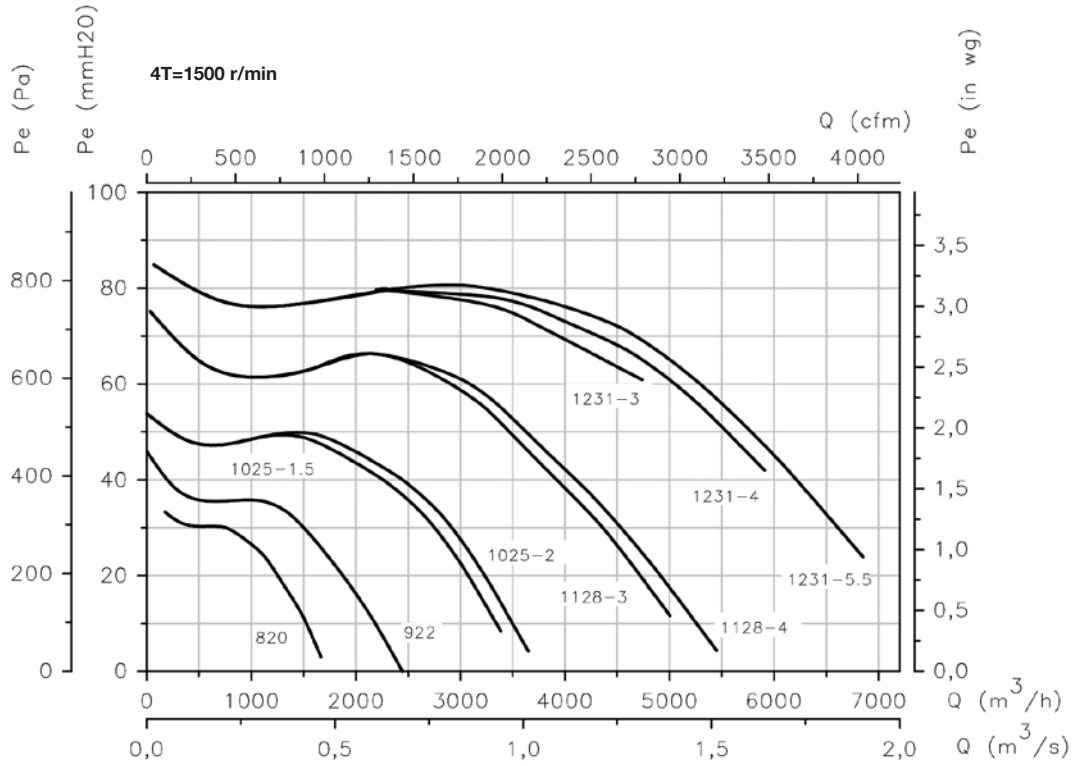

**Curvas características**

Q= Caudal en m<sup>3</sup>/h, m<sup>3</sup>/s y cfm.

Pe= Presión estática en mmH<sub>2</sub>O, Pa e inwg.

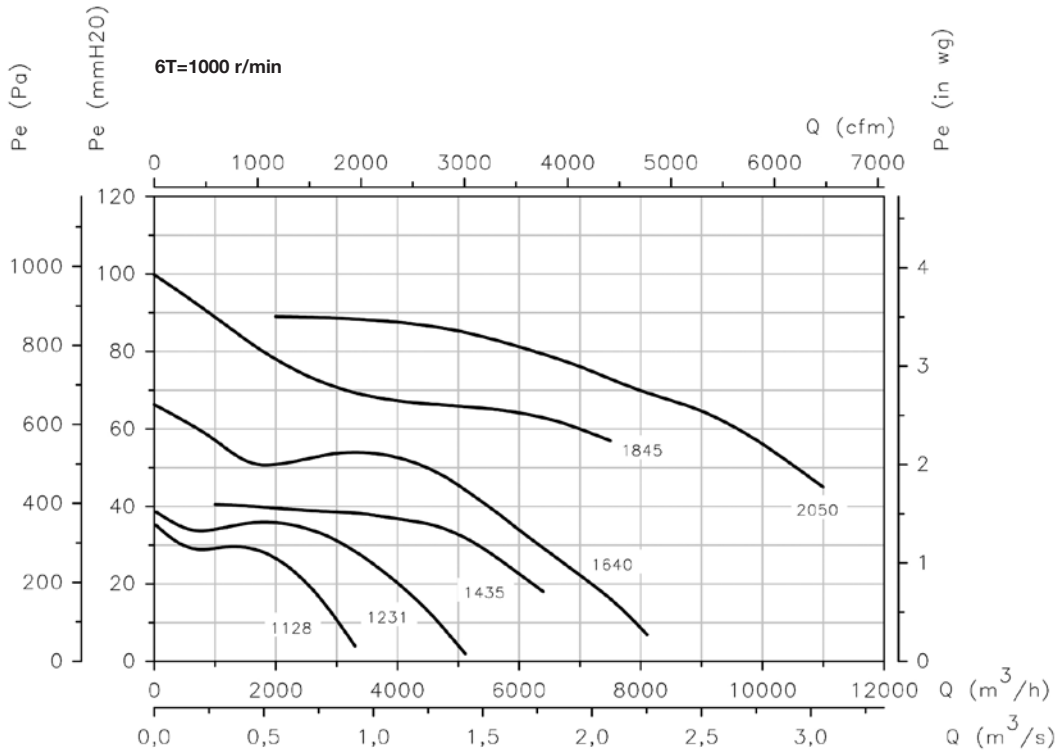

**Orientaciones**

Suministro standard LG 270

Posiciones LG 180 y RD 180 bajo demanda y con medidas de anclaje especiales.



**Accesorios**

Ver apartado accesorios

